



Guangdong Perfect Co.,Ltd.



HO.RE.CA
2023-2024

Enterprise Profile

Guangdong Perfect Co., Ltd. was established in 2003, which specializes in Research, Development, Production, and Sales of Metal & Plastic Merchandise for Hotel, Bar, Oriental & Western Kitchens.

Guangdong Perfect Co., Ltd. has its own factory covering an area of 30,000 square meters. There are some departments including Technical development, Molding, Hardware, Injection, Rotation and Packing. Based on our strong economic strength, we have introduced some advanced facilities & technologies for future achievement.

Guangdong Perfect Co., Ltd. has a group of high-tech professionals with over ten years' experience in product research and development. Matching an united, progressive, disciplined and pragmatic sales team. We concentrate on product design, research & development, production and marketing. Also on providing satisfied services and high-quality goods to our customers. Meanwhile, we are recognized as a leader in this field. Developing our enterprise culture to enhance our core competitiveness and to build a good social image.

Guangdong Perfect Co., Ltd. is absorbed in building up long-term partnerships with our employees, suppliers and clients, ensuring to exceed customers' expectation of our services, quality, value and dependability.

After we have received many awards of product innovation and being recognized by our outstanding services. Moreover, our own brand **JJWINS®** is widely accepted by our customers and has obtained public praise from this field.

Adhere to people-oriented, mutual Win-Win business philosophy, we have been working with comprehensive partners over 80 countries in the worldwide market. We wish more opportunities could be provided to you with our excellent services.

We value more and more on ABSORPTION.—“Absorption Coheres Energy: Absorption achieves Future”. We're sincerely looking forward to cooperating with you and creating a Win-Win future.



CONTENTS

Glass Racks Products

Glass Racks & Cup Keepers 03-08

Storage Products

NEW GN PAN 10-21

Square Storage Container 22-23

Round Storage Container 24-25

Food Storage Box 26-27

Food Storage Pan Sliding Lid 28

Food Preparation Pan 28

Beverage Dispenser 28

Ingredient Bins 29

Shelf Ingredient Bins 29

Dough Storage Box 30

Ingredient Container 31

NEW Salad Spinner 32

Versa Organizers 33

NEW Food Box With Locking Lid 33

NEW 4-Section Slanted Cup Dispenser 33

Tabletop Products

Beverage Tumblers 35-41

NEW Fast Food Trays 42-43

Buffetwares 44-49

Food Covers 50

Barwares Products

Plastic Barware 51-56

Shelving Products

Winshelvings 57-70

NEW Composite Shelving 71-78

NEW Wire Shelvings 79-86

Faucet Products

Mounted Faucet 88-89

Pot and Kettle Filler 90

Wall munted Retractable
Hose Reel 91

Workboard and Pantry Faucets 92-106

Glass Filler & Glass Rinse 98

NEW Single hole Deck
Mount Sensor Faucet 99

Waste Valves 104

NEW Foot Valve & Service Sink Faucet 100

Faucet Accessories 101

Insulated Transport Products

NEW Drink Server 103

Insulated Pan Carrier 104

NEW Premium Series
Insulated Pan Carrier 105

NEW Electric Heating Food Pan Carriers 106

Insulated Pan 107

Sliding Ice Caddy 107

EPP Insulated Pan Carrier 108-109

Cooling and Warming Food Box 110

Food Service Cart Products

NEW Plate Rack 112-115

Wall Mount Plate Rack 116

26 Sheet Pan Rack 117

Tray Table Ware Cart 118

NEW Mutiduty Service Cart 119

Collapsible Laundry Cart 120

NEW Cube Trucks 121

Folding Cart 122

NEW Heavy-duty Platform Trucks 123-124

Baby Chair

Dinner Chair 126

Baby Chair 126

NEW Baby Changing Stations 126

Cleaning Products

Compact Cleaning Cart 128

Luxury Compact Cleaning Cart 129

Multifunctional Cleaning Cart 129

High Capacity Cleaning Cart 130

Triple Capacity Cart 130

Innovative Cleaning Cart 131

Luxury Cleaning Cart 132

Medical Places Special
Cleaning Cart 132

NEW Accessories 133

Housekeeping Cart 134-135

Step-on Container 136

Recycling Slim Container 137

Vented Channel Container 138

NEW Recycle Round Container 139

NEW Cleaning Tool 140-141

NEW Upright Electric Glass Washer 143

Five Brush Electric Glass Polisher 144

Product Index

Product Index 145-153

*This booklet and dimensions are for reference only, please according to the real object.

New Product



Glass Racks
Page 03



GN PAN
Page 13



Salad Spinner
Page 32



4-Section Slanted Cup Dispenser
Page 33



Composite Shelving
Page 72



GN Pan Trolley
Page 83



Premium Series Insulated Pan Carrier
Page 105



Cube Trucks
Page 122

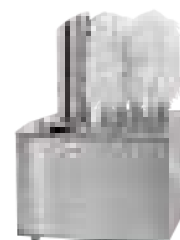

Five Brush Electric Glass Polisher
Page 144

Glass Racks

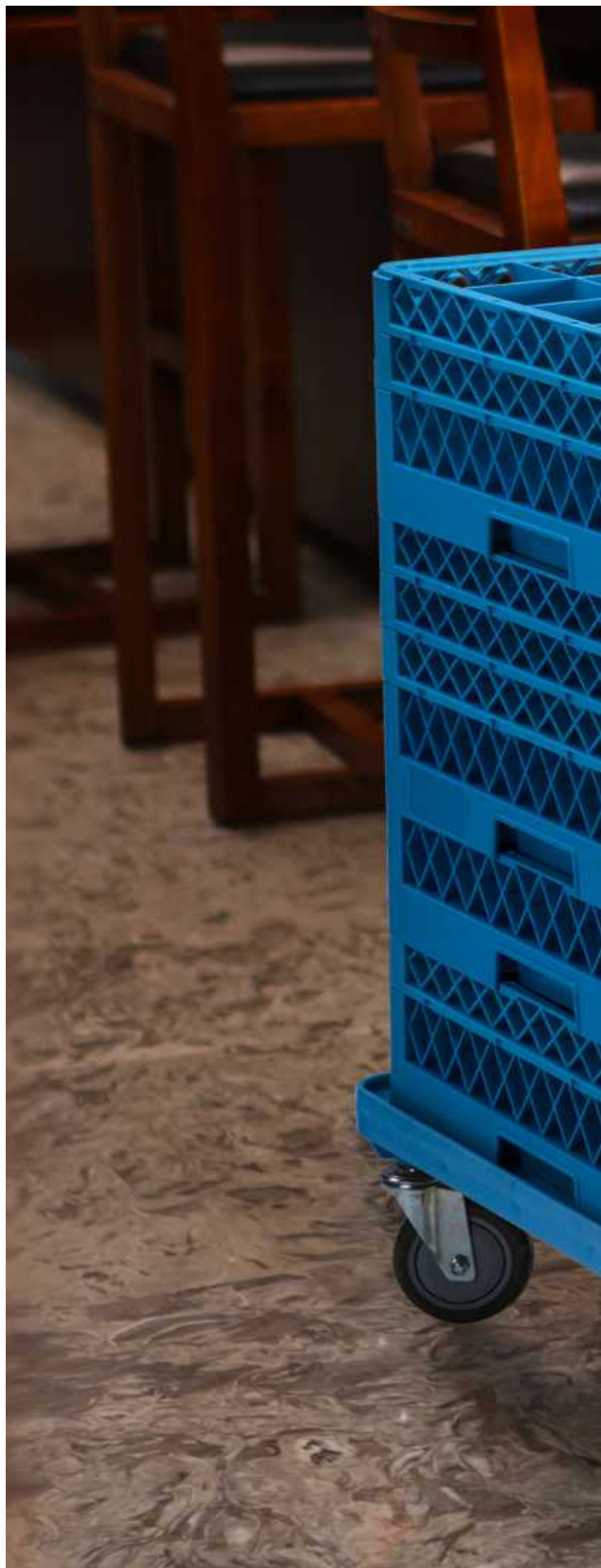
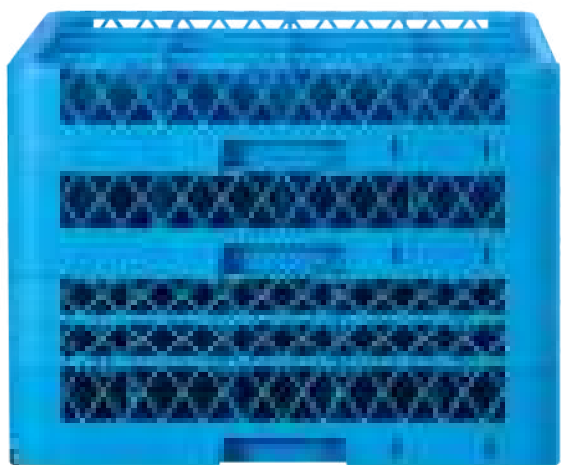



Glass Racks

Features

No need for rewashing, efficiently saving time and cost. keep the glassware cleaner.

Open Profile

Allows top-to-bottom and side-to-side washing, making the glassware cleaner. Allows more air to circulate through the racks and makes faster drying and safer storing.

Stackability

Snap-fit construction shortens assembly time, and stacks all racks tightly.

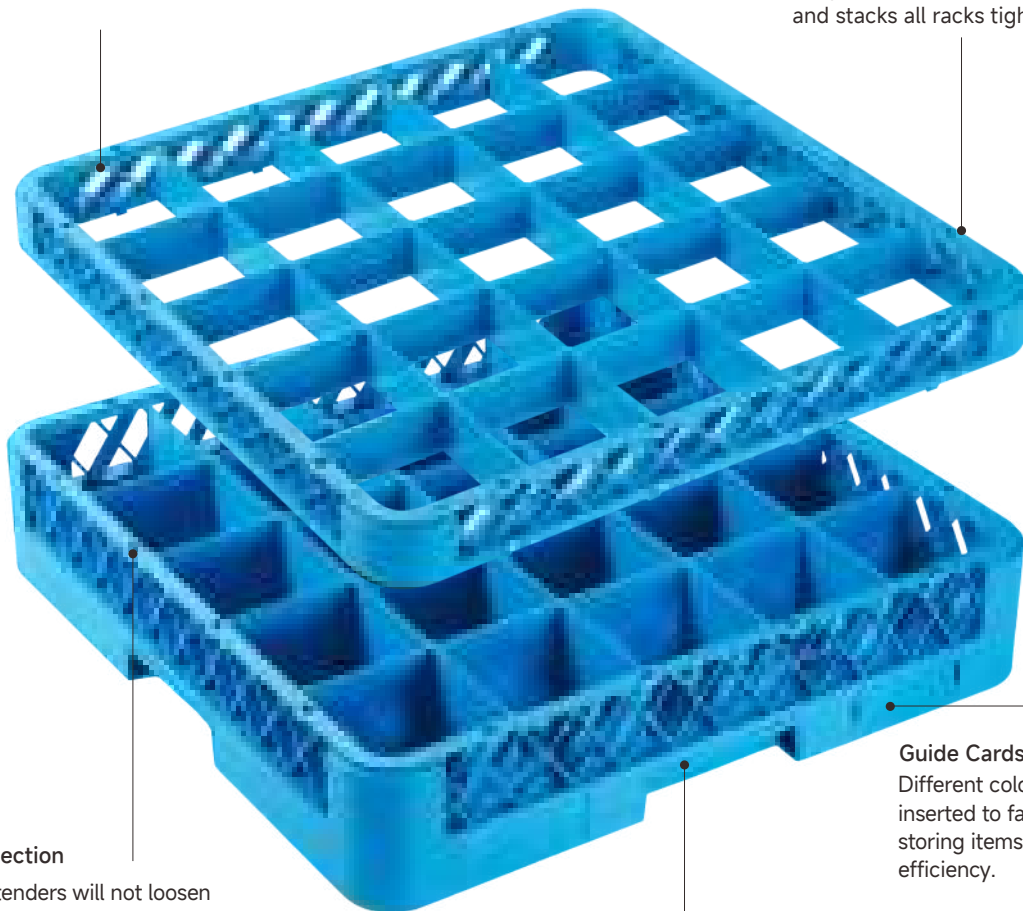

Tight Connection

Snap-fit extenders will not loosen or rust over time like screws and will not come apart.



Guide Cards Groove

Different coloured cards can be inserted to facilitate identifying storing items and improve work efficiency.



Convenient Handle

The handles on all four sides of the racks are convenient for safe delivery. Textured surface and convenient handles can avoid scratches when carried .

Glass Racks

Glass Rack Sizing Guide Instruction

1. Place glass upside down on top of the middle circle of the sizing guide, center of the glass should be over the center of the guide.
2. Look down on the base of the glass.
3. Note the smallest square on the guide where the largest outside diameter of the glass lines up completely within the square without touching it. That is the number of compartments our rack needs to have.
4. Place lip of glass against the base line of the vertical guide on the right-hand side of the page with the base/foot of the glass pointing straight up towards the top of the page.
5. While holding the glass against the vertical guide, note where the base/foot of the glass lines up on the vertical guide. The next line above the base/foot on the guide indicates the number of extenders your rack will require.
6. Glasses with a maximum height exceeding 242mm will need more than five extenders. Each extender adds approximately 40mm of additional height to the inside compartment of the rack.

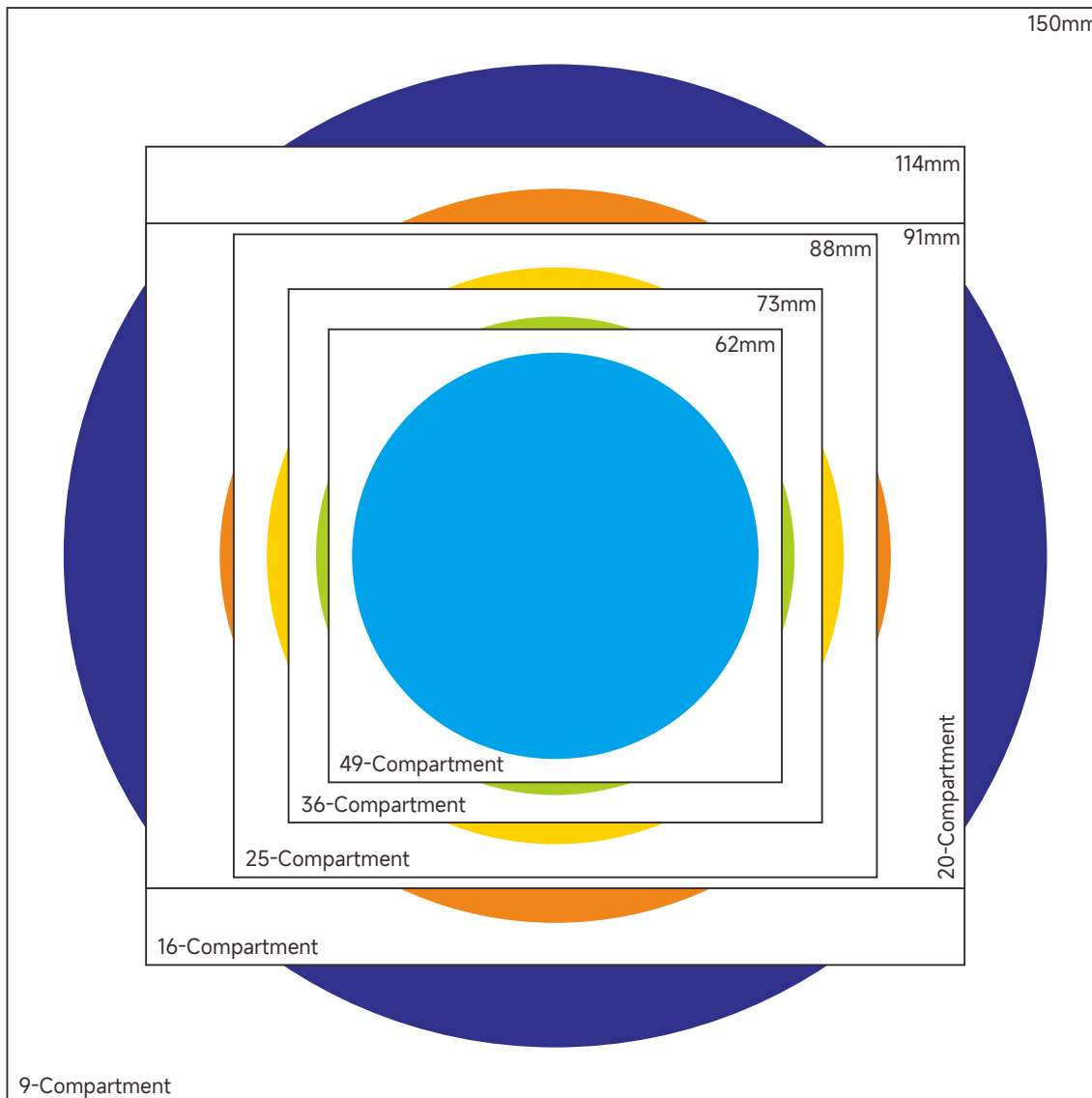

242mm
Glass Racks
With 4 Extender

202mm
Glass Racks
With 3 Extender

162mm
Glass Racks
With 2 Extender

122mm
Glass Racks
With Extender

82mm
Glass Racks

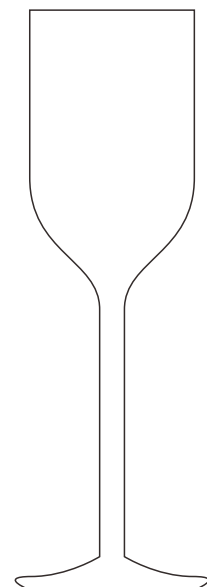

Glass Racks



| Art.No. | JW-92 | JW-9 | |
|--------------|---------------------------------|--------------------------|--|
| Name | 9-Compartment Standard Extender | 9-Compartment Glass Rack | 9-Compartment Glass Rack With 1 Extender |
| Overall Size | 500x500x45 mm | 500x500x100 mm | 500x500x140 mm |
| Comp.Size | 150x150x40 mm | 150x150x82 mm | 150x150x123 mm |
| Colour | Blue | Blue | Blue |
| Material | PP | PP | PP |
| PCS/CTN | 6 | 6 | |



| Art.No. | JW-162 | JW-16 | |
|--------------|----------------------------------|---------------------------|---|
| Name | 16-Compartment Standard Extender | 16-Compartment Glass Rack | 16-Compartment Glass Rack With 1 Extender |
| Overall Size | 500x500x45 mm | 500x500x100 mm | 500x500x140 mm |
| Comp.Size | 114x114x40 mm | 114x114x82 mm | 114x114x123 mm |
| Colour | Blue | Blue | Blue |
| Material | PP | PP | PP |
| PCS/CTN | 6 | 6 | |



| Art.No. | JW-202 | JW-20 | |
|--------------|----------------------------------|---------------------------|---|
| Name | 20-Compartment Standard Extender | 20-Compartment Glass Rack | 20-Compartment Glass Rack With 1 Extender |
| Overall Size | 500x500x45 mm | 500x500x100 mm | 500x500x140 mm |
| Comp.Size | 114x91x40 mm | 114x91x82 mm | 114x91x123 mm |
| Colour | Blue | Blue | Blue |
| Material | PP | PP | PP |
| PCS/CTN | 6 | 6 | |

Glass Racks

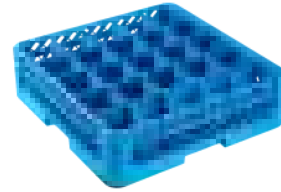
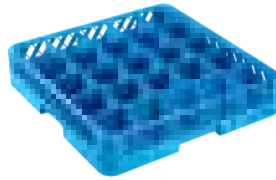
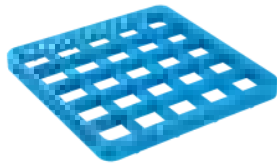

| | | | |
|--------------|----------------------------------|---------------------------|---|
| Art.No. | JW-252 | JW-25 | |
| Name | 25-Compartment Standard Extender | 25-Compartment Glass Rack | 25-Compartment Glass Rack With 1 Extender |
| Overall Size | 500x500x45 mm | 500x500x100 mm | 500x500x140 mm |
| Comp.Size | 88x88x40 mm | 88x88x82 mm | 88x88x123 mm |
| Colour | Blue | Blue | Blue |
| Material | PP | PP | PP |
| PCS/CTN | 6 | 6 | |

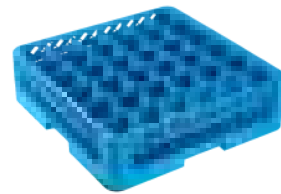
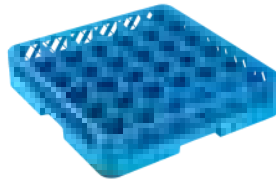
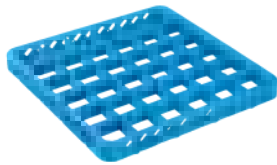

| | | | |
|--------------|----------------------------------|---------------------------|---|
| Art.No. | JW-362 | JW-36 | |
| Name | 36-Compartment Standard Extender | 36-Compartment Glass Rack | 36-Compartment Glass Rack With 1 Extender |
| Overall Size | 500x500x45 mm | 500x500x100 mm | 500x500x140 mm |
| Comp.Size | 73x73x40 mm | 73x73x82 mm | 73x73x123 mm |
| Colour | Blue | Blue | Blue |
| Material | PP | PP | PP |
| PCS/CTN | 6 | 6 | |

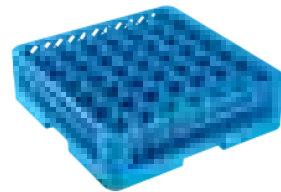
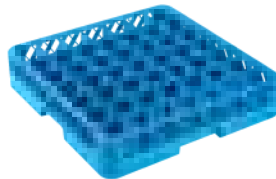
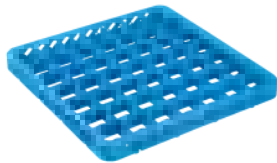

| | | | |
|--------------|----------------------------------|---------------------------|---|
| Art.No. | JW-492 | JW-49 | |
| Name | 49-Compartment Standard Extender | 49-Compartment Glass Rack | 49-Compartment Glass Rack With 1 Extender |
| Overall Size | 500x500x45 mm | 500x500x100 mm | 500x500x140 mm |
| Comp.Size | 62x62x40 mm | 62x62x82 mm | 62x62x123 mm |
| Colour | Blue | Blue | Blue |
| Material | PP | PP | PP |
| PCS/CTN | 6 | 6 | |

Glass Racks



| Art.No. | JW-S | JW-C | JW-64I |
|--------------|----------------|----------------|---------------------------|
| Name | Open Rack | Cutlery Rack | 64-Compartment Inser Rack |
| Overall Size | 500x500x100 mm | 500x500x100 mm | 468x468x75 mm |
| Comp.Size | 36x36mm | 10x10mm | 55x55x75mm |
| Colour | Blue | Blue | Blue |
| Material | PP | PP | PP |
| PCS/CTN | 6 | 6 | 6 |



| Art.No. | JW-25B | JW-25P | JW-64B |
|--------------|----------------------------------|---------------------------------------|----------------------------------|
| Name | 25-Compartment Plate & Tray Rack | 25-Compartment Open Plate & Tray Rack | 64-Compartment Plate & Tray Rack |
| Overall Size | 500x500x100 mm | 500x500x100 mm | 500x500x100 mm |
| Comp.Size | 65x65x66 mm | 65x65x66 mm | 45x45x72 mm |
| Colour | Blue | Blue | Blue |
| Material | PP | PP | PP |
| PCS/CTN | 6 | 6 | 6 |



| Art.No. | JW-64P | JW-8B | JW-8BH | JW-1017 |
|--------------|---------------------------------------|---|--|------------------------------|
| Name | 64-Compartment Open Plate & Tray Rack | 8-Compartment Cutlery Basket Without Handle | 8-Compartment Cutlery Basket With Handle | 10/17-Compartment Glass Rack |
| Overall Size | 500x500x100 mm | 427x208x151 mm | 427x208x151 mm | 506x256x102 mm |
| Comp.Size | 45x45x72 mm | 90x90x110 mm | 90x90x110 mm | 27x27 mm |
| Colour | Blue | Blue | Blue | Blue |
| Material | PP | PP | PP | PP |
| PCS/CTN | 6 | 12 | 12 | 6 |



| Art.No. | JW-102 | JW-103 | JW-172 | JW-173 |
|--------------|---------------------------------|----------------------------------|---------------------------------|----------------------------------|
| Name | 10-Compartment Dropped Extender | 10-Compartment Standard Extender | 17-Compartment Dropped Extender | 17-Compartment Standard Extender |
| Overall Size | 502x252x125 mm | 502x252x125 mm | 502x252x125 mm | 502x252x125 mm |
| Comp.Size | 90x90x84 mm | 90x90x41 mm | 75x75x84 mm | 75x75x84mm |
| Colour | Blue | Blue | Blue | Blue |
| Material | PP | PP | PP | PP |
| PCS/CTN | 6 | 6 | 6 | 6 |

Note: JW-1017, JW-102, JW-103, JW-172, JW-173 require a MOQ 1200pcs

Glass Racks



| Art.No. | JW-FCS | JW-FCC | JW-FCR | JW-FHR | JW-4C |
|--------------|--|---|---------------------------|-------------------------|---------------------------|
| Name | Sparse Bottom Square Knife & Fork Basket | Dense Bottom Square Knife & Fork Basket | Round Knife & Fork Basket | Square Knife & Fork Box | 4-Compartment Cutlery Box |
| Overall Size | 107x107x139 mm | 107x107x139 mm | 107x107x135 mm | 295x170x125 mm | 520x285x95 mm |
| Comp.Size | - | - | - | - | 240x110x90 mm |
| Colour | White | White | White | Grey | Grey/Black |
| Material | PP | PP | PP | PP | PP |
| PCS/CTN | 48 | 48 | 48 | 24 | 12 |



| Art.No. | JW-GRC | JW-FRS | JW-P | JW-FRC |
|--------------|------------------------------|-------------------|---------------|------------------|
| Name | Guide Cards | Floor Rack System | Open Extender | Glass Rack Cover |
| Overall Size | 108x47x20 mm | 335x335x38 mm | 500x500x45 mm | 505x505x26 mm |
| Colour | Yellow/Green/Black/White/Red | Grey | Blue | Blue |
| Material | PP | PP | PP | PP |
| PCS/CTN | 504 | 12 | 16 | 36 |



| Art.No. | JW-RT | JW-ST |
|--------------|---------------------------|------------------------|
| Name | Rack Dolly Without Handle | Rack Dolly With Handle |
| Overall Size | 540x540x185 mm | 540x540x785 mm |
| Load-bearing | 150KG | 150KG |
| Colour | Blue | Blue |
| Material | PP | S/S, PP |
| PCS/CTN | 1 | 1 |

Glass & Cup Keepers



| Art.No. | JW-GK20 | JW-CK12 |
|--------------|---------------|-------------|
| Name | Glass Keepers | Cup Keepers |
| Overall Size | 455x355 mm | 455x355 mm |
| Comp.Size | 20 Cups | 12 Cups |
| Colour | White | White |
| Material | ABS | ABS |
| PCS/CTN | 24 | 24 |

The largest inner diameter of the glass: 66mm
 The largest inner diameter of the teacup: 74mm



Storage Products



Efficient and convenient flip hinge lid that keeps food safe



Easy-to-read capacity indicators



Features good fresh keeping.



PC GN Pan



PC GN Pan

- Features good fresh keeping.
- Durable construction makes no deforming, no hollowing and no cracking.
- Smooth interior makes clean up easy.
- Withstands temperatures from- 40°C to 99°C (-40°F-210°F)
- Colour: Clear, Black.

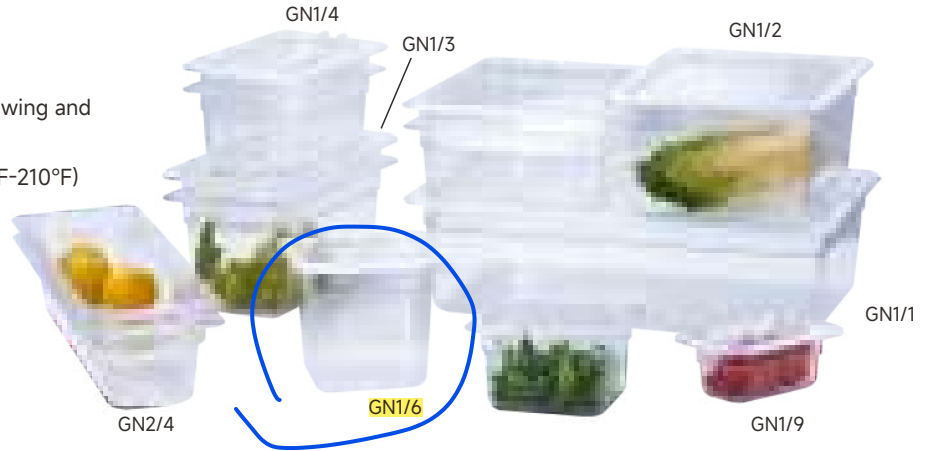

Cover with Handle
Deep molded handle provides secure grip.



Clear and Smooth Surface
Allows for a viewing of contents;
Smooth interior makes clean up easy.

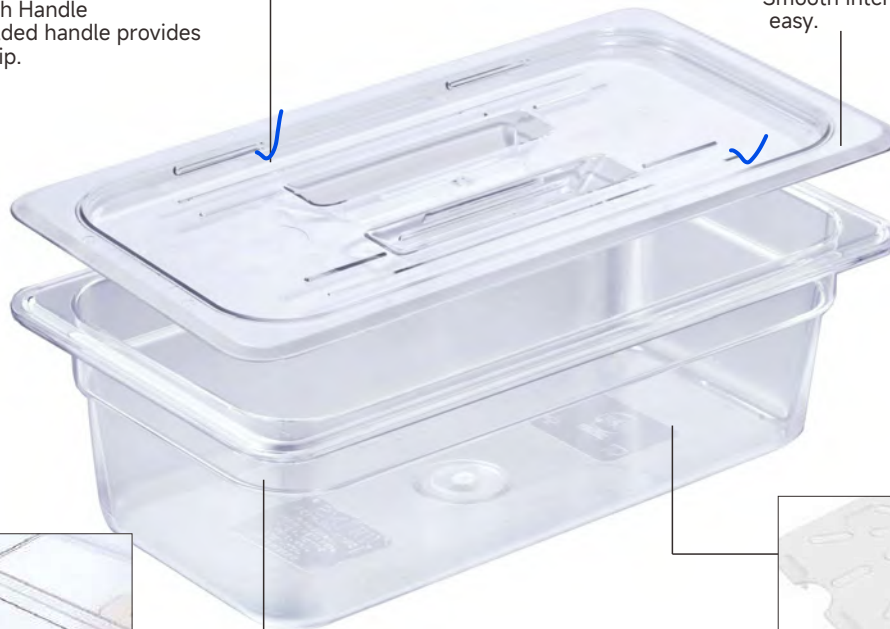

Capacity Marks
Sides are marked both in liters and quarts capacities for easy inventory management.



Drain Shelves
Available in sizes of 1/1,1/2, 1/3,1/4,1/6,supports contents and facilitates drainage.

Drain Shelves

- Available in sizes of 1/1,1/2,1/3,1/4,1/6.
- It supports contents and facilitates drainage.
- Colour: Clear, Black.



PP GN Pan

PP GN Pan



- Hardly absorbs dust or causes fouling, keeping food clean and fresh.
- Made of environmental material polypropylene, inodorous, atoxic and easy clean-up.
- An economical choice for food storage.
- Withstands temperatures from -15°C to 80°C (5°F-176°F).
- Colour: Clear



PC GN Tray

- GN trays are made of durable PC. Which ensures no deformation or break. Non-stick smooth exterior cleans up easily and quickly.
- Withstands temperatures form -40°C to 99°C
- Colour: Black.
- Material: PC



GN Pan Lids



| Name | Art.No | Size | PCS/CTN |
|------------------|------------|---------------|---------|
| Flat Lid | JW-P21FC | 645x525x25 mm | 12 |
| | JW-P11FC | 530x325 mm | 12 |
| | JW-P12FC | 325x265 mm | 12 |
| | JW-P13FC | 325x176 mm | 24 |
| | JW-P14FC | 265x162 mm | 24 |
| | JW-P16FC | 176x162 mm | 48 |
| | JW-P19HC | 176x108 mm | 48 |
| JW-P24HC | 530x162 mm | 24 | |
| Handle Lid | JW-P11HC | 530x325 mm | 12 |
| | JW-P12HC | 325x265 mm | 12 |
| | JW-P13HC | 325x176 mm | 24 |
| | JW-P14HC | 265x162 mm | 24 |
| | JW-P16HC | 176x162 mm | 48 |
| Notched Lid | JW-P11HH | 530x325 mm | 12 |
| | JW-P12HH | 325x265 mm | 12 |
| | JW-P13HH | 325x176 mm | 24 |
| | JW-P14HH | 265x162 mm | 24 |
| | JW-P16HH | 176x162 mm | 48 |
| JW-P19HH | 176x108 mm | 48 | |
| Flip Lid | JW-P12FL | 325x265 mm | 12 |
| | JW-P13FL | 325x176 mm | 24 |
| | JW-P16FL | 176x162 mm | 48 |
| Notched Flip Lid | JW-P12FLN | 325x265 mm | 12 |
| | JW-P13FLN | 325x176 mm | 24 |
| | JW-P16FLN | 176x162 mm | 48 |
| Seal Lid | JW-P11SL | 532x328 mm | 12 |
| | JW-P12SL | 327x268 mm | 12 |
| | JW-P13SL | 327x179 mm | 24 |
| | JW-P14SL | 267x164 mm | 24 |
| | JW-P16SL | 176x165 mm | 48 |
| JW-P19SL | 179x111 mm | 48 | |

GN Pans (PP/PC)



| Specification | Art.No | Height | Capacity | PCS/CTN |
|--------------------|---------|--------|----------|---------|
| GN2/1 650x530mm | JW-P216 | 150mm | 24L | 6 |
| | JW-P218 | 200mm | 36L | 6 |



| | | | | |
|--------------------|----------|-------------|---------------|----|
| GN1/1 530x325mm | JW-P112 | 65mm | 8.5L | 6 |
| | JW-P114 | 100mm | 13.0L | 6 |
| | JW-P116 | 150mm | 19.5L | 6 |
| | JW-P118 | 200mm | 25.6L | 6 |
| | JW-P11DS | Drain Shelf | 460X250X19 mm | 12 |



| | | | | |
|---------------------|----------|-------------|---------------|----|
| GN1/2 325x265 mm | JW-P122 | 65mm | 3.9L | 6 |
| | JW-P124 | 100mm | 5.9L | 6 |
| | JW-P126 | 150mm | 8.9L | 6 |
| | JW-P128 | 200mm | 11.7L | 6 |
| | JW-P12DS | Drain Shelf | 256x196x15 mm | 12 |



| | | | | |
|---------------------|----------|-------------|-----------------|----|
| GN1/3 325x176 mm | JW-P132 | 65mm | 2.4L | 24 |
| | JW-P134 | 100mm | 3.6L | 24 |
| | JW-P136 | 150mm | 5.3L | 24 |
| | JW-P138 | 200mm | 6.9L | 24 |
| | JW-P13DS | Drain Shelf | 262x112x18.5 mm | 24 |



| | | | | |
|---------------------|----------|-------------|---------------|----|
| GN1/4 265x162 mm | JW-P142 | 65mm | 1.7L | 24 |
| | JW-P144 | 100mm | 2.5L | 24 |
| | JW-P146 | 150mm | 3.7L | 24 |
| | JW-P14DS | Drain Shelf | 210x108x15 mm | 24 |



| | | | | |
|---------------------|----------|-------------|---------------|----|
| GN1/6 176x162 mm | JW-P162 | 65mm | 1.0L | 48 |
| | JW-P164 | 100mm | 1.5L | 48 |
| | JW-P166 | 150mm | 2.2L | 48 |
| | JW-P16DS | Drain Shelf | 123x108x15 mm | 48 |



| | | | | |
|---------------------|---------|-------|-------|----|
| GN1/9 176x108 mm | JW-P192 | 65mm | 0.57L | 48 |
| | JW-P194 | 100mm | 0.85L | 48 |



| | | | | |
|---------------------|---------|-------|-------|----|
| GN2/4 530x162 mm | JW-P242 | 65mm | 5.58L | 12 |
| | JW-P244 | 100mm | 8.58L | 12 |



| | | | | |
|------------|----------|--|--|----|
| 530x320 mm | JW-C2113 | PC GN Tray(1/1, 1/2, 1/3, 1/4, 1/6, 1/9) | | 12 |
| 320x260 mm | JW-C1310 | PC GN Tray(1/2, 1/3, 1/4, 1/6, 1/9) | | 24 |

European S/S Gn Pan

European S/S Gn Pan

-Gn pan is made of thick, high quality stainless steel that is built to last.
-It can be used for cooking, storing, keep food hot/ cold and serving.

-European styles: anti-jamming design, have stiffeners to avoid sticking together.

-Easy to storage: same size can be stacked together, able to save space when not in use.

Easy clean up: Clean with detergent and wipe dry.



Stackable, prevent jamming during storage, easy to take out











Large Handle for easying & closing cover

Smooth interior makes clean up easy.



Perforated Gn Pan

European Gn Pan S/S#201

| Specification | Art.No | Thickness | Height | Material | PCS/CTN |
|--|----------|-----------|--------|----------|---------|
|  GN2/1 650x325mm | E-SS2120 | 0.8 | 20mm | 201 | 6 |
| | E-SS2140 | 0.8 | 40mm | 201 | 6 |
| | E-SS2155 | 0.8 | 55mm | 201 | 6 |
| | E-SS212 | 0.8 | 65mm | 201 | 6 |
| | E-SS214 | 0.8 | 100mm | 201 | 6 |
| | E-SS216 | 0.8 | 150mm | 201 | 6 |
| | E-SS218 | 0.8 | 200mm | 201 | 6 |
|  GN1/1 530x325mm | E-SS1120 | 0.6 | 20mm | 201 | 6 |
| | E-SS1140 | 0.6 | 40mm | 201 | 6 |
| | E-SS1155 | 0.6 | 55mm | 201 | 6 |
| | E-SS112 | 0.6 | 65mm | 201 | 6 |
| | E-SS114 | 0.6 | 100mm | 201 | 6 |
| | E-SS116 | 0.7 | 150mm | 201 | 6 |
| | E-SS118 | 0.7 | 200mm | 201 | 6 |
|  GN2/3 353x325mm | E-SS2320 | 0.6 | 20mm | 201 | 12 |
| | E-SS2340 | 0.6 | 40mm | 201 | 12 |
| | E-SS2355 | 0.6 | 55mm | 201 | 12 |
| | E-SS232 | 0.6 | 65mm | 201 | 12 |
| | E-SS234 | 0.6 | 100mm | 201 | 12 |
| | E-SS236 | 0.7 | 150mm | 201 | 12 |
| | E-SS238 | 0.7 | 200mm | 201 | 12 |
|  GN1/2 325x265 mm | E-SS1220 | 0.6 | 20mm | 201 | 12 |
| | E-SS1240 | 0.6 | 40mm | 201 | 12 |
| | E-SS1255 | 0.6 | 55mm | 201 | 12 |
| | E-SS122 | 0.6 | 65mm | 201 | 12 |
| | E-SS124 | 0.6 | 100mm | 201 | 12 |
| | E-SS126 | 0.7 | 150mm | 201 | 12 |
| | E-SS128 | 0.7 | 200mm | 201 | 12 |
|  GN1/3 325x176 mm | E-SS1320 | 0.6 | 20mm | 201 | 18 |
| | E-SS1340 | 0.6 | 40mm | 201 | 18 |
| | E-SS1355 | 0.6 | 55mm | 201 | 18 |
| | E-SS132 | 0.6 | 65mm | 201 | 18 |
| | E-SS134 | 0.6 | 100mm | 201 | 18 |
| | E-SS136 | 0.7 | 150mm | 201 | 18 |
| | E-SS138 | 0.7 | 200mm | 201 | 18 |
|  GN1/4 265x162 mm | E-SS1420 | 0.6 | 20mm | 201 | 24 |
| | E-SS1440 | 0.6 | 40mm | 201 | 24 |
| | E-SS1455 | 0.6 | 55mm | 201 | 24 |
| | E-SS142 | 0.6 | 65mm | 201 | 24 |
| | E-SS144 | 0.6 | 100mm | 201 | 24 |
| | E-SS146 | 0.7 | 150mm | 201 | 24 |
| | E-SS148 | 0.7 | 200mm | 201 | 24 |
|  GN1/6 176x162 mm | E-SS162 | 0.6 | 65mm | 201 | 36 |
| | E-SS164 | 0.6 | 100mm | 201 | 36 |
| | E-SS166 | 0.7 | 150mm | 201 | 36 |
| | E-SS168 | 0.7 | 200mm | 201 | 36 |
|  GN1/9 176x108 mm | E-SS192 | 0.6 | 65mm | 201 | 48 |
| | E-SS194 | 0.6 | 100mm | 201 | 48 |
| | E-SS196 | 0.7 | 150mm | 201 | 48 |
|  GN2/4 530x162 mm | E-SS2440 | 0.6 | 40mm | 201 | 24 |
| | E-SS242 | 0.6 | 65mm | 201 | 24 |
| | E-SS244 | 0.6 | 100mm | 201 | 18 |
| | E-SS246 | 0.7 | 150mm | 201 | 12 |

European Perforated Gn Pan S/S#201



| Specification | Art.No | Thickness | Height | Material | PCS/CTN |
|--------------------|-----------|-----------|--------|----------|---------|
| GN2/1 650x325mm | E-SS2120P | 0.8 | 20mm | 201 | 6 |
| | E-SS2140P | 0.8 | 40mm | 201 | 6 |
| | E-SS2155P | 0.8 | 55mm | 201 | 6 |
| | E-SS212P | 0.8 | 65mm | 201 | 6 |
| | E-SS214P | 0.8 | 100mm | 201 | 6 |
| | E-SS216P | 0.8 | 150mm | 201 | 6 |
| | E-SS218P | 0.8 | 200mm | 201 | 6 |



| | | | | | |
|--------------------|-----------|-----|-------|-----|---|
| GN1/1 530x325mm | E-SS1120P | 0.6 | 20mm | 201 | 6 |
| | E-SS1140P | 0.6 | 40mm | 201 | 6 |
| | E-SS1155P | 0.6 | 55mm | 201 | 6 |
| | E-SS112P | 0.6 | 65mm | 201 | 6 |
| | E-SS114P | 0.6 | 100mm | 201 | 6 |
| | E-SS116P | 0.7 | 150mm | 201 | 6 |
| | E-SS118P | 0.7 | 200mm | 201 | 6 |



| | | | | | |
|--------------------|-----------|-----|-------|-----|----|
| GN2/3 353x325mm | E-SS2320P | 0.6 | 20mm | 201 | 12 |
| | E-SS2340P | 0.6 | 40mm | 201 | 12 |
| | E-SS2355P | 0.6 | 55mm | 201 | 12 |
| | E-SS232P | 0.6 | 65mm | 201 | 12 |
| | E-SS234P | 0.6 | 100mm | 201 | 12 |
| | E-SS236P | 0.7 | 150mm | 201 | 12 |
| | E-SS238P | 0.7 | 200mm | 201 | 12 |



| | | | | | |
|---------------------|-----------|-----|-------|-----|----|
| GN1/2 325x265 mm | E-SS1220P | 0.6 | 20mm | 201 | 12 |
| | E-SS1240P | 0.6 | 40mm | 201 | 12 |
| | E-SS1255P | 0.6 | 55mm | 201 | 12 |
| | E-SS122P | 0.6 | 65mm | 201 | 12 |
| | E-SS124P | 0.6 | 100mm | 201 | 12 |
| | E-SS126P | 0.7 | 150mm | 201 | 12 |
| | E-SS128P | 0.7 | 200mm | 201 | 12 |



| | | | | | |
|---------------------|-----------|-----|-------|-----|----|
| GN1/3 325x176 mm | E-SS1320P | 0.6 | 20mm | 201 | 18 |
| | E-SS1340P | 0.6 | 40mm | 201 | 18 |
| | E-SS1355P | 0.6 | 55mm | 201 | 18 |
| | E-SS132P | 0.6 | 65mm | 201 | 18 |
| | E-SS134P | 0.6 | 100mm | 201 | 18 |
| | E-SS136P | 0.7 | 150mm | 201 | 18 |
| | E-SS138P | 0.7 | 200mm | 201 | 18 |

| Specification | Art.No | Thickness | Size | Material | PCS/CTN |
|---------------|----------|-----------|-----------|----------|---------|
| Handle Lid | E-SS21HC | 0.8 | 650x530mm | 201 | 6 |
| | E-SS11HC | 0.7 | 530x325mm | 201 | 6 |
| | E-SS23HC | 0.7 | 353x325mm | 201 | 12 |
| | E-SS12HC | 0.7 | 325x265mm | 201 | 12 |
| | E-SS13HC | 0.7 | 325x176mm | 201 | 18 |
| | E-SS14HC | 0.7 | 265x162mm | 201 | 24 |
| | E-SS16HC | 0.7 | 176x162mm | 201 | 36 |
| | E-SS19HC | 0.7 | 176x108mm | 201 | 48 |
| | E-SS24HC | 0.7 | 530x162mm | 201 | 12 |



| | | | | | |
|-----------|-----------|-----|-----------|-----|----|
| Notch Lid | E-SS21HCS | 0.9 | 650x530mm | 201 | 6 |
| | E-SS11HCS | 0.7 | 530x325mm | 201 | 6 |
| | E-SS23HCS | 0.7 | 353x325mm | 201 | 12 |
| | E-SS12HCS | 0.7 | 325x265mm | 201 | 12 |
| | E-SS13HCS | 0.7 | 325x176mm | 201 | 18 |
| | E-SS14HCS | 0.7 | 265x162mm | 201 | 24 |
| | E-SS16HCS | 0.7 | 176x162mm | 201 | 36 |
| | E-SS19HCS | 0.7 | 176x108mm | 201 | 48 |
| | E-SS24HCS | 0.7 | 530x162mm | 201 | 12 |



European Gn Pan S/S#304



| Specification | Art.No | Thickness | Height | Material | PCS/CTN |
|--------------------|-----------|-----------|--------|----------|---------|
| GN2/1 650x325mm | E-SS42120 | 1.0 | 20mm | 304 | 10 |
| | E-SS42140 | 0.8 | 40mm | 304 | 10 |
| | E-SS4212 | 0.8 | 65mm | 304 | 10 |
| | E-SS4214 | 0.8 | 100mm | 304 | 6 |
| | E-SS4216 | 0.8 | 150mm | 304 | 6 |



| | | | | | |
|--------------------|-----------|-----|-------|-----|----|
| GN1/1 530x325mm | E-SS41120 | 0.7 | 20mm | 304 | 10 |
| | E-SS41140 | 0.7 | 40mm | 304 | 10 |
| | E-SS4112 | 0.7 | 65mm | 304 | 10 |
| | E-SS4114 | 0.7 | 100mm | 304 | 10 |
| | E-SS4116 | 0.7 | 150mm | 304 | 10 |
| | E-SS4118 | 0.7 | 200mm | 304 | 10 |



| | | | | | |
|--------------------|-----------|-----|-------|-----|----|
| GN2/3 353x325mm | E-SS42320 | 0.7 | 20mm | 304 | 30 |
| | E-SS42340 | 0.7 | 40mm | 304 | 20 |
| | E-SS4232 | 0.7 | 65mm | 304 | 20 |
| | E-SS4234 | 0.7 | 100mm | 304 | 20 |
| | E-SS4236 | 0.7 | 150mm | 304 | 10 |
| | E-SS4238 | 0.7 | 200mm | 304 | 10 |



| | | | | | |
|---------------------|-----------|-----|-------|-----|----|
| GN1/2 325x265 mm | E-SS41220 | 0.7 | 20mm | 304 | 30 |
| | E-SS41240 | 0.7 | 40mm | 304 | 20 |
| | E-SS4122 | 0.7 | 65mm | 304 | 20 |
| | E-SS4124 | 0.7 | 100mm | 304 | 20 |
| | E-SS4126 | 0.7 | 150mm | 304 | 10 |
| | E-SS4128 | 0.7 | 200mm | 304 | 10 |



| | | | | | |
|---------------------|-----------|-----|-------|-----|----|
| GN1/3 325x176 mm | E-SS41320 | 0.7 | 20mm | 304 | 40 |
| | E-SS41340 | 0.7 | 40mm | 304 | 30 |
| | E-SS4132 | 0.7 | 65mm | 304 | 20 |
| | E-SS4134 | 0.7 | 100mm | 304 | 20 |
| | E-SS4136 | 0.7 | 150mm | 304 | 20 |
| | E-SS4138 | 0.7 | 200mm | 304 | 20 |



| | | | | | |
|---------------------|-----------|-----|-------|-----|----|
| GN1/4 265x162 mm | E-SS41420 | 0.7 | 20mm | 304 | 40 |
| | E-SS41440 | 0.7 | 40mm | 304 | 20 |
| | E-SS4142 | 0.7 | 65mm | 304 | 20 |
| | E-SS4144 | 0.7 | 100mm | 304 | 20 |
| | E-SS4146 | 0.7 | 150mm | 304 | 20 |
| | E-SS4148 | 0.7 | 200mm | 304 | 20 |



| | | | | | |
|---------------------|----------|-----|-------|-----|----|
| GN1/6 176x162 mm | E-SS4162 | 0.7 | 65mm | 304 | 20 |
| | E-SS4164 | 0.7 | 100mm | 304 | 20 |
| | E-SS4166 | 0.7 | 150mm | 304 | 20 |
| | E-SS4168 | 0.7 | 200mm | 304 | 20 |



| | | | | | |
|---------------------|----------|-----|-------|-----|----|
| GN1/9 176x108 mm | E-SS4192 | 0.7 | 65mm | 304 | 20 |
| | E-SS4194 | 0.7 | 100mm | 304 | 20 |
| | E-SS4196 | 0.7 | 150mm | 304 | 20 |



| | | | | | |
|---------------------|----------|-----|-------|-----|----|
| GN2/4 530x160 mm | E-SS4242 | 0.7 | 65mm | 304 | 20 |
| | E-SS4244 | 0.7 | 100mm | 304 | 20 |
| | E-SS4246 | 0.7 | 150mm | 304 | 10 |

European Perforated Gn Pan S/S#304



| Specification | Art.No | Thickness | Height | Material | PCS/CTN |
|--------------------|------------|-----------|--------|----------|---------|
| GN1/1 530x325mm | E-SS41120P | 0.7 | 20mm | 304 | 10 |
| | E-SS41140P | 0.7 | 40mm | 304 | 10 |
| | E-SS4112P | 0.7 | 65mm | 304 | 10 |
| | E-SS4114P | 0.7 | 100mm | 304 | 10 |
| | E-SS4116P | 0.7 | 150mm | 304 | 10 |
| | E-SS4118P | 0.7 | 200mm | 304 | 10 |



| | | | | | |
|---------------------|------------|-----|-------|-----|----|
| GN1/2 325x265 mm | E-SS41220P | 0.7 | 20mm | 304 | 30 |
| | E-SS41240P | 0.7 | 40mm | 304 | 20 |
| | E-SS4122P | 0.7 | 65mm | 304 | 20 |
| | E-SS4124P | 0.7 | 100mm | 304 | 20 |
| | E-SS4126P | 0.7 | 150mm | 304 | 10 |
| | E-SS4128P | 0.7 | 200mm | 304 | 10 |









| Specification | Art.No | Thickness | Size | Material | PCS/CTN |
|---------------|-----------|-----------|-----------|----------|---------|
| Handle Lid | E-SS411HC | 0.7 | 530x325mm | 304 | 10 |
| | E-SS423HC | 0.7 | 353x325mm | 304 | 20 |
| | E-SS412HC | 0.7 | 325x265mm | 304 | 20 |
| | E-SS413HC | 0.7 | 325x176mm | 304 | 20 |
| | E-SS414HC | 0.7 | 265x162mm | 304 | 20 |
| | E-SS416HC | 0.7 | 176x162mm | 304 | 40 |
| | E-SS419HC | 0.7 | 176x108mm | 304 | 40 |
| | E-SS424HC | 0.7 | 530x160mm | 304 | 20 |



| | | | | | |
|-----------|------------|-----|-----------|-----|----|
| Notch Lid | E-SS411HCS | 0.7 | 530x325mm | 304 | 10 |
| | E-SS423HCS | 0.7 | 353x325mm | 304 | 20 |
| | E-SS412HCS | 0.7 | 325x265mm | 304 | 20 |
| | E-SS413HCS | 0.7 | 325x176mm | 304 | 20 |
| | E-SS414HCS | 0.7 | 265x162mm | 304 | 20 |
| | E-SS416HCS | 0.7 | 176x162mm | 304 | 40 |
| | E-SS419HCS | 0.7 | 176x108mm | 304 | 40 |
| | E-SS424HCS | 0.7 | 530x160mm | 304 | 20 |



US Steam Pan S/S#201

| Specification | Art.No | Thickness | Height | Material | PCS/CTN |
|--|----------|-----------|--------|----------|---------|
|  GN1/1 530x325mm | A-SS1125 | 0.6 | 25mm | 201 | 6 |
| | A-SS1140 | 0.6 | 40mm | 201 | 6 |
| | A-SS112 | 0.6 | 65mm | 201 | 6 |
| | A-SS114 | 0.6 | 100mm | 201 | 6 |
| | A-SS116 | 0.6 | 150mm | 201 | 6 |
| | A-SS118 | 0.6 | 200mm | 201 | 6 |
|  GN2/3 353x325mm | A-SS2325 | 0.6 | 25mm | 201 | 12 |
| | A-SS2340 | 0.6 | 40mm | 201 | 12 |
| | A-SS232 | 0.6 | 65mm | 201 | 12 |
| | A-SS234 | 0.6 | 100mm | 201 | 12 |
| | A-SS236 | 0.6 | 150mm | 201 | 12 |
| | A-SS238 | 0.6 | 200mm | 201 | 12 |
|  GN1/2 325x265 mm | A-SS1225 | 0.6 | 25mm | 201 | 12 |
| | A-SS1240 | 0.6 | 40mm | 201 | 12 |
| | A-SS122 | 0.6 | 65mm | 201 | 12 |
| | A-SS124 | 0.6 | 100mm | 201 | 12 |
| | A-SS126 | 0.6 | 150mm | 201 | 12 |
| | A-SS128 | 0.6 | 200mm | 201 | 12 |
|  GN1/3 325x176 mm | A-SS132 | 0.6 | 65mm | 201 | 18 |
| | A-SS134 | 0.6 | 100mm | 201 | 18 |
| | A-SS136 | 0.6 | 150mm | 201 | 18 |
| | A-SS138 | 0.6 | 200mm | 201 | 18 |
|  GN1/4 265x162 mm | A-SS142 | 0.6 | 65mm | 201 | 24 |
| | A-SS144 | 0.6 | 100mm | 201 | 24 |
| | A-SS146 | 0.6 | 150mm | 201 | 24 |
| | A-SS148 | 0.6 | 200mm | 201 | 24 |
|  GN1/6 176x162 mm | A-SS162 | 0.6 | 65mm | 201 | 36 |
| | A-SS164 | 0.6 | 100mm | 201 | 36 |
| | A-SS166 | 0.6 | 150mm | 201 | 36 |
| | A-SS168 | 0.6 | 200mm | 201 | 36 |
|  GN1/9 176x108 mm | A-SS192 | 0.6 | 65mm | 201 | 48 |
| | A-SS194 | 0.6 | 100mm | 201 | 48 |
| | A-SS196 | 0.6 | 150mm | 201 | 48 |

US Perforated Steam Pan S/S#201



| Specification | Art.No | Thickness | Height | Material | PCS/CTN |
|--------------------|-----------|-----------|--------|----------|---------|
| GN1/1 530x325mm | A-SS1125P | 0.6 | 25mm | 201 | 6 |
| | A-SS1140P | 0.6 | 40mm | 201 | 6 |
| | A-SS112P | 0.6 | 65mm | 201 | 6 |
| | A-SS114P | 0.6 | 100mm | 201 | 6 |
| | A-SS116P | 0.6 | 150mm | 201 | 6 |
| | A-SS118P | 0.6 | 200mm | 201 | 6 |



| | | | | | |
|--------------------|-----------|-----|-------|-----|----|
| GN2/3 353x325mm | A-SS2325P | 0.6 | 25mm | 201 | 12 |
| | A-SS2340P | 0.6 | 40mm | 201 | 12 |
| | A-SS232P | 0.6 | 65mm | 201 | 12 |
| | A-SS234P | 0.6 | 100mm | 201 | 12 |
| | A-SS236P | 0.6 | 150mm | 201 | 12 |
| | A-SS238P | 0.6 | 200mm | 201 | 12 |











| | | | | | |
|---------------------|-----------|-----|-------|-----|----|
| GN1/2 325x265 mm | A-SS1225P | 0.6 | 25mm | 201 | 12 |
| | A-SS1240P | 0.6 | 40mm | 201 | 12 |
| | A-SS122P | 0.6 | 65mm | 201 | 12 |
| | A-SS124P | 0.6 | 100mm | 201 | 12 |
| | A-SS126P | 0.6 | 150mm | 201 | 12 |
| | A-SS128P | 0.6 | 200mm | 201 | 12 |



| Specification | Art.No | Thickness | Size | Material | PCS/CTN |
|---------------|----------|-----------|-----------|----------|---------|
| Handle Lid | A-SS11HC | 0.6 | 530x325mm | 201 | 6 |
| | A-SS23HC | 0.6 | 353x325mm | 201 | 12 |
| | A-SS12HC | 0.6 | 325x265mm | 201 | 12 |
| | A-SS13HC | 0.6 | 325x176mm | 201 | 18 |
| | A-SS14HC | 0.6 | 265x162mm | 201 | 24 |
| | A-SS16HC | 0.6 | 176x162mm | 201 | 36 |
| | A-SS19HC | 0.6 | 176x108mm | 201 | 48 |



US Steam Pan S/S#304

| Specification | Art.No | Thickness | Height | Material | PCS/CTN |
|--|-----------|-----------|--------|----------|---------|
|  GN1/1 530x325mm | A-SS41125 | 0.7 | 25mm | 304 | 10 |
| | A-SS4112 | 0.7 | 65mm | 304 | 10 |
| | A-SS4114 | 0.7 | 100mm | 304 | 10 |
| | A-SS4116 | 0.7 | 150mm | 304 | 10 |
| | A-SS4118 | 0.7 | 200mm | 304 | 10 |
|  GN2/3 355x325mm | A-SS4232 | 0.7 | 65mm | 304 | 20 |
| | A-SS4234 | 0.7 | 100mm | 304 | 20 |
| | A-SS4236 | 0.7 | 150mm | 304 | 10 |
| | A-SS4238 | 0.7 | 200mm | 304 | 10 |
|  GN1/2 325x265 mm | A-SS41225 | 0.7 | 25mm | 304 | 20 |
| | A-SS4122 | 0.7 | 65mm | 304 | 20 |
| | A-SS4124 | 0.7 | 100mm | 304 | 20 |
| | A-SS4126 | 0.7 | 150mm | 304 | 10 |
| | A-SS4128 | 0.7 | 200mm | 304 | 10 |
|  GN1/3 325x176 mm | A-SS4132 | 0.7 | 65mm | 304 | 20 |
| | A-SS4134 | 0.7 | 100mm | 304 | 20 |
| | A-SS4136 | 0.7 | 150mm | 304 | 20 |
| | A-SS4138 | 0.7 | 200mm | 304 | 20 |
|  GN1/4 265x162 mm | A-SS4142 | 0.7 | 65mm | 304 | 20 |
| | A-SS4144 | 0.7 | 100mm | 304 | 20 |
| | A-SS4146 | 0.7 | 150mm | 304 | 20 |
|  GN1/6 176x162 mm | A-SS4162 | 0.7 | 65mm | 304 | 20 |
| | A-SS4164 | 0.7 | 100mm | 304 | 20 |
| | A-SS4166 | 0.7 | 150mm | 304 | 20 |
|  GN1/9 176x108 mm | A-SS4192 | 0.7 | 65mm | 304 | 20 |
| | A-SS4194 | 0.7 | 100mm | 304 | 20 |
|  GN2/4 530x160 mm | A-SS4242 | 0.7 | 65mm | 304 | 20 |
| | A-SS4244 | 0.7 | 100mm | 304 | 20 |
| | A-SS4246 | 0.7 | 150mm | 304 | 10 |

US Perforated Steam Pan S/S#201



| Specification | Art.No | Thickness | Height | Material | PCS/CTN |
|--------------------|------------|-----------|--------|----------|---------|
| GN1/1 530x325mm | A-SS41125P | 0.7 | 25mm | 304 | 10 |
| | A-SS4112P | 0.7 | 65mm | 304 | 10 |
| | A-SS4114P | 0.7 | 100mm | 304 | 10 |
| | A-SS4116P | 0.7 | 150mm | 304 | 10 |
| | A-SS4118P | 0.7 | 200mm | 304 | 10 |



| | | | | | |
|---------------------|------------|-----|-------|-----|----|
| GN1/2 325x265 mm | A-SS41225P | 0.7 | 25mm | 304 | 20 |
| | A-SS4122P | 0.7 | 65mm | 304 | 20 |
| | A-SS4124P | 0.7 | 100mm | 304 | 20 |
| | A-SS4126P | 0.7 | 150mm | 304 | 10 |
| | A-SS4128P | 0.7 | 200mm | 304 | 10 |



| Specification | Art.No | Thickness | Size | Material | PCS/CTN |
|---------------|-----------|-----------|-----------|----------|---------|
| Handle Lid | A-SS411HC | 0.7 | 530x325mm | 304 | 10 |
| | A-SS423HC | 0.7 | 355x325mm | 304 | 20 |
| | A-SS412HC | 0.7 | 325x265mm | 304 | 20 |
| | A-SS413HC | 0.7 | 325x176mm | 304 | 20 |
| | A-SS414HC | 0.7 | 265x162mm | 304 | 20 |
| | A-SS416HC | 0.7 | 176x162mm | 304 | 40 |
| | A-SS419HC | 0.7 | 176x108mm | 304 | 40 |
| | A-SS424HC | 0.7 | 530x160mm | 304 | 20 |



| | | | | | |
|-----------|------------|-----|-----------|-----|----|
| Notch Lid | A-SS411HCS | 0.7 | 530x325mm | 304 | 10 |
| | A-SS423HCS | 0.7 | 355x325mm | 304 | 20 |
| | A-SS412HCS | 0.7 | 325x265mm | 304 | 20 |
| | A-SS413HCS | 0.7 | 325x176mm | 304 | 20 |
| | A-SS414HCS | 0.7 | 265x162mm | 304 | 20 |
| | A-SS416HCS | 0.7 | 176x162mm | 304 | 40 |
| | A-SS419HCS | 0.7 | 176x108mm | 304 | 40 |
| | A-SS424HCS | 0.7 | 530x160mm | 304 | 20 |



Square Food Storage Container



Contents and Date Indicators on Lid
Spare space of the lid can be marked with contents and date indicators, convenient to keep the quality and freshness of food.



Textured Lid
Made of polyethylene; Non-slip textured surface is resistant to scratches and helps more stable stacking.



Wide and Easy Handles
Wide molded-in and textured finish handles in larger sizes ease carrying. Drain holes in handles allow for quicker drying. Wide cove handles save effort when transported and do not waste space.



Stackable lugs
Corner stackable lugs add strength rigidity and prevent jamming when stacked.



Date indicator
Date indicators on all four sides for easy recognition.



Textured Finish
All corners, edges, handles and the bottom are designed with textured finish. It can reduce scratches, increase service time and provide safe use.

PC Square Storage Container
Transparent polycarbonate allows for easy identification of products. Polycarbonate is extremely durable and stackable. Square shape allows for practical storage in the freezers and coolers. Withstands temperatures from -40°C to 99°C (-40°F-210°F)
Colour: Clear.



PP Square Storage Container
Made of polypropylene, economical and durable. It's a good choice for food storage. Dishwasher safe. Withstands temperatures from -15°C to 80°C (5°F-176°F).
Colour: Translucent, White

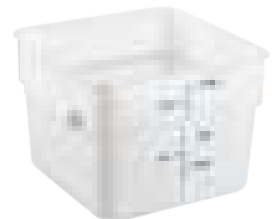

Square Food Storage Container



PC



| Art.No | P-060C | P-061C | P-062C | P-063C | P-064C | P-065C | P-066C |
|----------|-----------------------------|-----------------------------|-----------------------------|-----------------------------|------------------------------|------------------------------|------------------------------|
| Name | 2L Square Storage Container | 4L Square Storage Container | 6L Square Storage Container | 8L Square Storage Container | 12L Square Storage Container | 18L Square Storage Container | 22L Square Storage Container |
| Cover | P-080 | P-080 | P-081 | P-081 | P-082 | P-082 | P-082 |
| Size | 180x100 mm | 180x190 mm | 225x190 mm | 225x230 mm | 285x210 mm | 285x320 mm | 285x400 mm |
| Capacity | 2L | 4L | 6L | 8L | 12L | 18L | 22L |
| Colour | Clear | Clear | Clear | Clear | Clear | Clear | Clear |
| PCS/CTN | 60 | 48 | 24 | 24 | 12 | 12 | 6 |

PP



| Art.No | P-060P | P-061P | P-062P | P-063P | P-064P | P-065P | P-066P |
|----------|-----------------------------|-----------------------------|-----------------------------|-----------------------------|------------------------------|------------------------------|------------------------------|
| Name | 2L Square Storage Container | 4L Square Storage Container | 6L Square Storage Container | 8L Square Storage Container | 12L Square Storage Container | 18L Square Storage Container | 22L Square Storage Container |
| Cover | P-080 | P-080 | P-081 | P-081 | P-082 | P-082 | P-082 |
| Size | 180x100 mm | 180x190 mm | 225x190 mm | 225x230 mm | 285x210 mm | 285x320 mm | 285x400 mm |
| Capacity | 2L | 4L | 6L | 8L | 12L | 18L | 22L |
| Colour | Translucent/White | Translucent/White | Translucent/White | Translucent/White | Translucent/White | Translucent/White | Translucent/White |
| PCS/CTN | 60 | 48 | 24 | 24 | 12 | 12 | 6 |

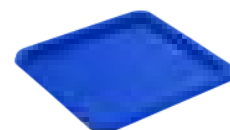

| Art.No | P-080 | P-081 | P-082 |
|---------|-----------|-----------|-----------|
| Name | Lid | Lid | Lid |
| Size | 187x17 mm | 230x16 mm | 290x15 mm |
| Colour | Green | Red | Blue |
| PCS/CTN | 12 | 12 | 6 |

PC Round Food Storage Container

- PC withstands temperatures from - 40°C to 99°C (-40°F-210°F).
- With high impact resistance, fouling resistance and chemical resistance.
- Convenient outside graduations help easier inventory management.
- Snap-on cover can seal up the container and make no leakage.
- Colour: Clear.



| | | | | |
|----------|----------------------------|----------------------------|----------------------------|----------------------------|
| Art.No | P-100C | P-101C | P-102C | P-103C |
| Name | 1L Round Storage Container | 2L Round Storage Container | 4L Round Storage Container | 6L Round Storage Container |
| Cover | P-090C | P-091C | P-091C | P-092C |
| Size | Φ130x126 mm | Φ188x108.5 mm | Φ188x215 mm | Φ226x199 mm |
| Capacity | 1L | 2L | 4L | 6L |
| Colour | Clear | Clear | Clear | Clear |
| PCS/CTN | 48 | 24 | 12 | 12 |



| | | | | |
|----------|------------------------------|-----------------------------|-----------------------------|-----------------------------|
| Art.No | P-104C | P-105C | P-106C | P-107C |
| Name | 7.5L Round Storage Container | 10L Round Storage Container | 15L Round Storage Container | 20L Round Storage Container |
| Cover | P-092C | P-093C | P-093C | P-093C |
| Size | Φ226x274mm | Φ315x214 mm | Φ315x304 mm | Φ315x378 mm |
| Capacity | 7.5L | 10L | 15L | 20L |
| Colour | Clear | Clear | Clear | Clear |
| PCS/CTN | 12 | 12 | 6 | 6 |



| | | | | |
|---------|----------------|------------|--------------|-----------|
| Art.No | P-090C | P-091C | P-092C | P-093C |
| Name | Lid | Lid | Lid | Lid |
| Size | Φ135.5x10.1 mm | Φ192x12 mm | Φ232x12.1 mm | Φ320x15mm |
| Colour | Clear | Clear | Clear | Clear |
| PCS/CTN | 12 | 12 | 12 | 6 |

PP Round Food Storage Container

- PP withstands temperatures from -15°C to 80°C.
- With high impact resistance, fouling resistance and chemical resistance.
- Convenient outside graduations help easier inventory management.
- Snap-on cover can seal up the container and make no leakage.
- Colour: Translucent,White.



| Art.No | P-100P | P-101P | P-102P | P-103P |
|----------|----------------------------|----------------------------|----------------------------|----------------------------|
| Name | 1L Round Storage Container | 2L Round Storage Container | 4L Round Storage Container | 6L Round Storage Container |
| Cover | P-090P | P-091P | P-091P | P-092P |
| Size | Φ130x126 mm | Φ188x108.5 mm | Φ188x215 mm | Φ226x199 mm |
| Capacity | 1L | 2L | 4L | 6L |
| Colour | Translucent/White | Translucent/White | Translucent/White | Translucent/White |
| PCS/CTN | 48 | 24 | 12 | 12 |



| Art.No | P-104P | P-105P | P-106P | P-107P |
|----------|------------------------------|-----------------------------|-----------------------------|-----------------------------|
| Name | 7.5L Round Storage Container | 10L Round Storage Container | 15L Round Storage Container | 20L Round Storage Container |
| Cover | P-092P | P-093P | P-093P | P-093P |
| Size | Φ226x274mm | Φ315x214 mm | Φ315x304 mm | Φ315x378 mm |
| Capacity | 7.5L | 10L | 15L | 20L |
| Colour | Translucent/White | Translucent/White | Translucent/White | Translucent/White |
| PCS/CTN | 12 | 12 | 6 | 6 |



| Art.No | P-090P | P-091P | P-092P | P-093P |
|---------|-------------------|-------------------|-------------------|-------------------|
| Name | Lid | Lid | Lid | Lid |
| Size | Φ135.5x10.1 mm | Φ192x12 mm | Φ232x12.1 mm | Φ320x15mm |
| Colour | Translucent/White | Translucent/White | Translucent/White | Translucent/White |
| PCS/CTN | 12 | 12 | 12 | 6 |

PC Food Storage Box

- Clear polycarbonate is a break-resistant material.
- Allows for easy recognition of inside products.
- Can be used in freezer or refrigerator.
- Withstands temperatures from - 40°C to 99°C (-40°F-210°F).



| Art.No. | P-072C | P-067C | P-068C | P-073C |
|-------------|-----------------------|------------------------|----------------------|----------------------|
| Name | 6.6L Food Storage Box | 11.4L Food Storage Box | 18L Food Storage Box | 19L Food Storage Box |
| Cover | P-083C | P-083C | P-083C | P-084C |
| Drain Shelf | P06DS | P06DS | P06DS | P07DS |
| Size | 460x300x90 mm | 460x300x150 mm | 460x300x230 mm | 662x460x90 mm |
| Capacity | 6.6L | 11.4L | 18L | 19L |
| Colour | Clear | Clear | Clear | Clear |
| PCS/CTN | 12 | 12 | 12 | 6 |

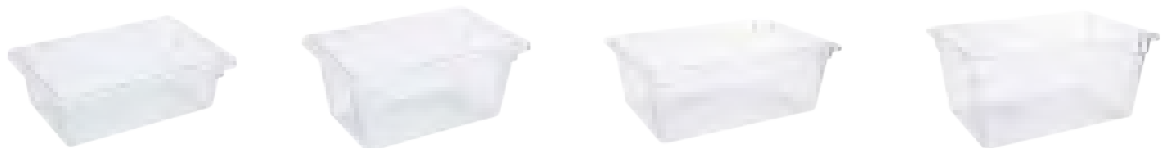

| Art.No. | P-069C | P-070C | P-071C | P-074C |
|-------------|----------------------|------------------------|----------------------|------------------------|
| Name | 33L Food Storage Box | 49.2L Food Storage Box | 64L Food Storage Box | 83.3L Food Storage Box |
| Cover | P-084C | P-084C | P-084C | P-084C |
| Drain Shelf | P07DS | P07DS | P07DS | P07DS |
| Size | 662x460x150 mm | 662x460x240 mm | 662x460x315 mm | 662x460x385 mm |
| Capacity | 33L | 49.2L | 64L | 83.3L |
| Colour | Clear | Clear | Clear | Clear |
| PCS/CTN | 6 | 6 | 6 | 6 |



| Art.No. | P-083C | P-084C | P06DS | P07DS |
|---------|--------------------------------|------------------------------|--|--------------------------------------|
| Name | Small Lid For Food Storage Box | Big Lid For Food Storage Box | Small Drain Shelf For Food Storage Box | Big Drain Shelf For Food Storage Box |
| Size | 460x300x30 mm | 662x460x31.5 mm | 355x205x15 mm | 555x355x16 mm |
| Colour | Clear | Clear | Clear | Clear |
| PCS/CTN | 12 | 12 | 24 | 24 |

PP Food Storage Box

- With capabilities of anti-impact, anti-fouling and anti-chemical corrosion.
- It is a more economical choice than PC.
- Withstands temperatures from -15°C to 80°C (5°F-176°F).



| | | | | |
|-------------|-----------------------|------------------------|----------------------|----------------------|
| Art.No. | P-072P | P-067P | P-068P | P-073P |
| Name | 6.6L Food Storage Box | 11.4L Food Storage Box | 18L Food Storage Box | 19L Food Storage Box |
| Cover | P-083P | P-083P | P-083P | P-084P |
| Drain Shelf | P06DSP | P06DSP | P06DSP | P07DSP |
| Size | 450x297x90 mm | 450x297x150 mm | 450x297x230 mm | 650x450x90 mm |
| Capacity | 6.6L | 11.4L | 18L | 19L |
| Colour | White | White | White | White |
| PCS/CTN | 12 | 12 | 12 | 6 |



| | | | | |
|-------------|----------------------|------------------------|----------------------|------------------------|
| Art.No. | P-069P | P-070P | P-071P | P-074P |
| Name | 33L Food Storage Box | 49.2L Food Storage Box | 64L Food Storage Box | 83.3L Food Storage Box |
| Cover | P-084P | P-084P | P-084P | P-084P |
| Drain Shelf | P07DSP | P07DSP | P07DSP | P07DSP |
| Size | 650x450x150 mm | 650x450x240 mm | 650x450x315 mm | 650x450x385 mm |
| Capacity | 33L | 49.2L | 64L | 83.3L |
| Colour | White | White | White | White |
| PCS/CTN | 6 | 6 | 6 | 6 |



| | | | | |
|---------|--------------------------------|------------------------------|--|--------------------------------------|
| Art.No. | P-083P | P-084P | P06DSP | P07DSP |
| Name | Small Lid For Food Storage Box | Big Lid For Food Storage Box | Small Drain Shelf For Food Storage Box | Big Drain Shelf For Food Storage Box |
| Size | 450x300x27 mm | 650x450x31.5 mm | 350x203x15 mm | 550x355x16 mm |
| Colour | White | White | White | White |
| PCS/CTN | 12 | 12 | 24 | 24 |

Food Storage Series

Food Storage Pan Sliding Lid

- The cover can be slid to the back to take out the ingredients.
- Can keep food fresh.
- Can prevent bacteria and cross contamination.
- Can identify the food materials easily.

The lid can be slid forward backward and also can be lifted, which makes the contents access easily.



| Art.No. | P-085 | P-086 |
|---------|------------------------------------|------------------------------------|
| Name | Small Food Storage Pan Sliding Lid | Large Food Storage Pan Sliding Lid |
| Size | 450x300x31 mm | 650x450x33 mm |
| Box | P-072C,P-067C,P-068C | P-073,P-069C,P-070C,P-071C,P-074C |
| Colour | White+Clear | White+Clear |
| PCS/CTN | 12 | 12 |

Food Preparation Pan

- Ideal for storing and transporting food.
- It is durable and won't crack or bend.
- Material:PC



| Art.No. | JW-MTP50 | JW-MTP55 | JW-MTP60 | JW-MTP65 | JW-MTP80 |
|----------|---------------------------|---------------------------|---------------------------|----------------------|---------------------------|
| Name | 1.7L Food Preparation Pan | 2.5L Food Preparation Pan | 4.4L Food Preparation Pan | 6.0L Preparation Pan | 9.6L Food Preparation Pan |
| Size | 270x210x50 mm | 305x240x55 mm | 360x280x60 mm | 420x296x65 mm | 480x335x80 mm |
| Capacity | 1.7L | 2.5L | 4.4L | 6.0L | 9.6L |
| Colour | Clear | Clear | Clear | Clear | Clear |
| PCS/CTN | 36 | 24 | 24 | 24 | 12 |

Note: This item requires a MOQ.

Beverage dispenser

- Perfect for mixing and serving concentrated beverages.
- Impact-resistant polypropylene can withstand temperature from -40°C to 70°C (-40°F-160°F),
- Colour:White

| | |
|----------|--------------------|
| Art.No. | JW-BD20 |
| Name | Beverage Dispenser |
| Size | Φ315x378 mm |
| Capacity | 20L |
| PCS/CTN | 4 |



Ingredient Bins/Shelf Ingredient Bins



Ingredient Bins

- Drawer-type cover design makes it easy to scoop raw materials up with one hand ,improving work efficiency.
- Insert rail for the scoop makes it easy to take out the scoop and doesn't make direct touch with the materials.
- Clear front cover helps quick identification of inside ingredients and better inventory management.
- Smooth interior and exterior makes clean-up easily.
- It can be easily moved with 3" castors.
- Ideal for storing dry bulk goods such as sugar, flour, rice and other cereals.



| Art.No. | JW-S81 | JW-S102 | JW-S120 |
|-------------------------|--------------------|---------------------|---------------------|
| Name | 81L Ingredient Bin | 102L Ingredient Bin | 120L Ingredient Bin |
| Size | 745x328x740 mm | 750x410x745 mm | 750x457x748 mm |
| Capacity | 81L | 102L | 120L |
| Weight Capacity (Sugar) | 72.7KG | 89.4KG | 106KG |
| Weight Capacity (Flour) | 56.3KG | 69.9KG | 83.5KG |
| Weight Capacity (Rice) | 81KG | 102KG | 120KG |
| PCS/CTN | 1 | 1 | 1 |



Shelf Ingredient Bins

- New and improved bins designed to store small amounts of food and ingredients.
- Patented cover; easy to take out the ingredients with one hand even when the bins are stacked.
- Clear cover for quick and easy identification of ingredients and better inventory management.
- Ideal for storing small amounts of ingredients.
- Material: PC, PP.
- Colour: White.



| Art.No. | JW-S8 | JW-S20 | JW-S40 |
|----------|-------------------------|--------------------------|--------------------------|
| Name | 8L Shelf Ingredient Bin | 20L Shelf Ingredient Bin | 40L Shelf Ingredient Bin |
| Size | 367x296x220 mm | 593x290x432 mm | 593x486x432 mm |
| Capacity | 8L | 20L | 40L |
| PCS/CTN | 1 | 1 | 1 |

Dough Storage Box



- Suitable for storing and transporting, proofing and cooling dough,
- Light, durable and break-resistant,
- Chemical-resistant, easy to clean and does not absorb odor.
- Can be stacked tightly, keep dust and contamination away, prolonging food freshness,
- Stacking reduces the demand of lids, saving cost,
- Withstands temperature from -40°C-70°C (-40°F-160°F) ,
- The lid can be used separately as a tray.



Box body can be stacked closely to isolate contaminants.



Humanized design of waving handles.

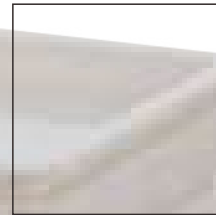

Installing universal wheels help easier transport.



| Art.No. | JW-DB18266 | JW-DB18263 | JW-DBC1826 | JW-SSD1826 |
|----------------|-----------------------|-------------------------|-----------------------|----------------|
| Name | Big Dough Storage Box | Small Dough Storage Box | Dough Storage Box Lid | Dolly |
| Size | 655x455x163 mm | 655x455x86 mm | 655x455x45 mm | 690x460x197 mm |
| Colour | White | White | White | Silver |
| Material | PP | PP | PP | Chrome |
| Product Weight | 2.2KG | 1.5KG | 1.2KG | 2.9KG |
| PCS/CTN | 6 | 6 | 6 | 1 |

Ingredient Container

- Rotating lid allows for one-handed operation.
- Clear lid for fast ingredient identification
- Safe and efficient food storage
- Different sizes are available:10gal/20gal/32gal
- Easy to be transported with JIWINS dollies(20gal/32gal).
- 20oz Big clear scoop allows for convenient access of ingredients.



P-046



| Art.No. | JW-CRCS38 | JW-CRCS76 | JW-CRCS120 | P-046 |
|-----------------------|----------------------------------|----------------------------------|----------------------------------|----------------------|
| Name | Sliding Lid For 10 Gal Container | Sliding Lid For 20 Gal Container | Sliding Lid For 32 Gal Container | 20oz Big Clear Scoop |
| Material | PP+PC | PP+PC | PP+PC | PC |
| Fit Container Art.No. | JW-CR38W | JW-CR76W | JW-CR120W | Together With Lid |
| Size | Φ437x76 mm | Φ533x82 mm | Φ599x85 mm | 140x104x250 mm |
| PCS/CTN | 6 | 6 | 6 | 6 |



| Art.No. | JW-CRC1P(WHITE) | JW-CRC2P(WHITE) | JW-CRC3P(WHITE) |
|-----------------------|--------------------------------|--------------------------------|--------------------------------|
| Name | Round Lid For 10 Gal Container | Round Lid For 20 Gal Container | Round Lid For 32 Gal Container |
| Material | PP | PP | PP |
| Fit Container Art.No. | JW-CR38W | JW-CR76W | JW-CR120W |
| Size | Φ410x28 mm | Φ510x40 mm | Φ570x38 mm |
| PCS/CTN | 24 | 12 | 12 |



| Art.No. | JW-CR38W | JW-CR76W | JW-CR120W |
|----------|-----------------------------|-----------------------------|-----------------------------|
| Name | 10 Gal Ingredient Container | 20 Gal Ingredient Container | 32 Gal Ingredient Container |
| Size | Φ398x434 mm | Φ492x584 mm | Φ557x693 mm |
| Colour | White | White | White |
| Material | PE | PE | PE |
| PCS/CTN | 6 | 6 | 6 |

Dolly for Recycle Round container

- 5 swivel casters offer better mobility in the working area.
- Snap-in construction makes it more stable.

Bearing:250 KG

 Colour:Black

 PCS/CTN: 2 PCS



JW-RCD



Salad Spinner

- Patent design, innovative brakes effectively improve the service life of gear.
- Sealed rotating system ensures food safety.
- Meets hygiene standards of FDA.
- Convenient side handles allow for quick and safe transport.
- Comfortable finger grip handle on the crank will maximize productivity and minimize operator fatigue.
- Suitable for kitchens in restaurants and hotels.



Sealed rotating system



Semi-open rotating system
Economic Salad Spinner



9.5L/2.5Gal



19L/5Gal
Economic Salad Spinner

| Art.No. | JW-SP9.5 | JW-SP19 | JW-ESP9.5 | JW-ESP19 |
|----------|---------------------|-------------------|------------------------------|----------------------------|
| Name | Small Salad Spinner | Big Salad Spinner | Small Economic Salad Spinner | Big Economic Salad Spinner |
| Size | Φ395x470 mm | Φ465x565 mm | Φ395x470 mm | Φ465x565 mm |
| Capacity | 9.5L/2.5Gal | 19L/5Gal | 9.5L/2.5Gal | 19L/5Gal |
| Colour | Orange | Orange | Orange | Orange |
| Weight | 3.3 kg | 4.3 kg | 3.3 kg | 4.3 kg |
| PCS/CTN | 1 | 1 | 1 | 1 |

Versa Organizer

- Used for storing condiments, cutlery, straws, napkins or other small items.
- Memo or note can be placed on the label area for easy distinguish.
- Holding bins can be combined into 2x3, 2x4, 3x3, or 3x4 dimensions.
- Boxes can be stacked, which saves a lot of space.
- The organizer can be placed on flat or can be wall-mount installed.
- The maximum bearing capacity is 54 KGS if it is wall-mounted.
- Bearing capacity for each box: 4.5 KGS.
- Material: Polypropylene, Aluminium alloy.

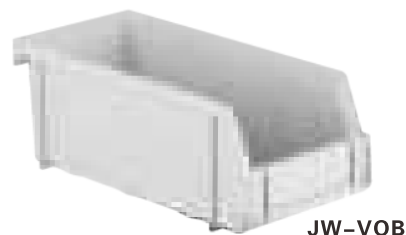

JW-VOB

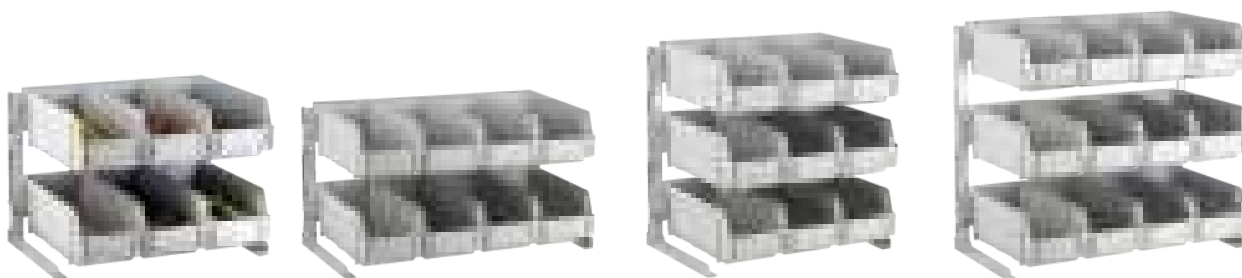

| Art.No. | JW-VOB | JW-VO23 | JW-VO24 | JW-VO33 | JW-VO34 |
|----------|----------------|--------------------|--------------------|--------------------|--------------------|
| Name | Organizers Box | 2x3 Organizers Box | 2x4 Organizers Box | 3x3 Organizers Box | 3x4 Organizers Box |
| Size | 293x127x109 mm | 440x310x300 mm | 568x310x300 mm | 440x310x475 mm | 568x310x475 mm |
| Colour | Spot dust | Spot dust | Spot dust | Spot dust | Spot dust |
| Material | PP | PP+Aluminium alloy | PP+Aluminium alloy | PP+Aluminium alloy | PP+Aluminium alloy |
| Weight | 0.32 KG | 3 KG | 3.8 KG | 4.4 KG | 5.6 KG |
| PCS/CTN | / | 12 | 9 | 8 | 6 |

Food Box With Locking Lid

- PP; With capabilities of anti-impact, anti-fouling and anti-chemical corrosion.
- Silicone seal ring, Cover with locking clips.
- Label recognition.

| Art.No. | 753 | 754 | 755 | 756 |
|----------|--------------------------------|------------------------------|--------------------------------|---------------------------------|
| Name | 2.5L Food Box With Locking Lid | 5L Food Box With Locking Lid | 7.5L Food Box With Locking Lid | 15.5L Food Box With Locking Lid |
| Size | 280x190x110 mm | 340x230x120 mm | 390x280x140 mm | 460x310x170 mm |
| Colour | Clear | Clear | Clear | Clear |
| Material | PP | PP | PP | PP |
| PCS/CTN | 60 | 40 | 30 | 20 |



4-Section Slanted Cup Dispenser

- For storing paper and plastic cups,
- Easy to categorize,
- Reasonable use of space, easy batch access to cups.

| Art.No. | JW-CD4 |
|----------|---------------------------------|
| Name | 4-Section Slanted Cup Dispenser |
| Size | 480x115x450 mm |
| Colour | Black/Red |
| Material | PP |
| Weight | 1.48 KG |
| PCS/CTN | 6 |



Tabletop Service Products

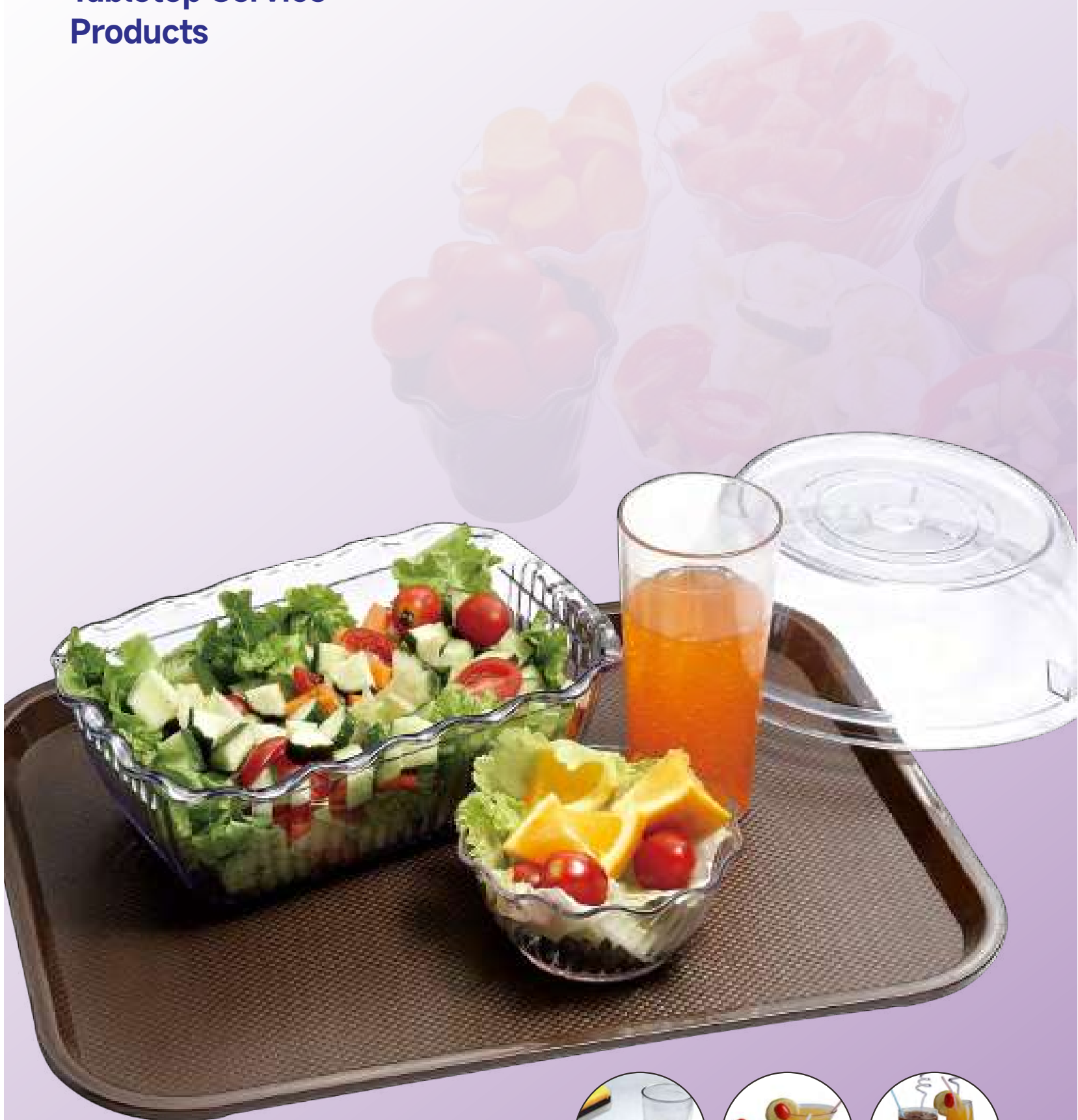

Beverage Tumblers

Stackable Round Base Tumblers

- Made of break-resistant polycarbonate or durable SAN, it's environment-friendly and sanitary.
- Stacking lugs prevent jamming when stored.
- The interior is easy to be cleaned.
- Widely used for drinks like water, ice tea, sodas or other.



| PC Art.No. AS Art.No. | JW-1006C JW-1006A | JW-1008C JW-1008A | JW-1009C JW-1009A | JW-1010C JW-1010A | JW-1012C JW-1012A | JW-1014C JW-1014A | JW-1016C JW-1016A | JW-1020C JW-1020A |
|--------------------------|----------------------|----------------------|----------------------|----------------------|----------------------|----------------------|----------------------|----------------------|
| Top Dia(cm) | 6.4 | 6.8 | 8.3 | 7.1 | 7.6 | 7.9 | 8.3 | 8.7 |
| Bottom Dia(cm) | 4.8 | 4.9 | 6 | 5.4 | 5.6 | 6 | 5.9 | 6.5 |
| Height(cm) | 9.4 | 10.2 | 8.4 | 11.6 | 13 | 12.7 | 14.6 | 16.5 |
| Capacity(ml/oz) | 189/6 | 228/7.3 | 275/8.8 | 300/9.65 | 373/12 | 414/13.3 | 485/15.6 | 650/21 |
| Material | PC/AS | PC/AS | PC/AS | PC/AS | PC/AS | PC/AS | PC/AS | PC/AS |
| Colour | Clear | Clear | Clear | Clear | Clear | Clear | Clear | Clear |
| PCS/CTN | 72 | 72 | 72 | 72 | 72 | 72 | 72 | 72 |

Note: This item requires a MOQ 3000pcs.

Popular Polycarbonate Tumblers

- Made of break-resistant polycarbonate or durable SAN, it's environment-friendly and sanitary.
- The surface does not wear down easily.
- With attractive design; smooth interior makes clean up easily.
- Ideal for bars, hotels or banquets



| PC Art.No. AS Art.No. | JW-2005C JW-2005A | JW-2008C JW-2008A | JW-2010C JW-2010A | JW-2120C JW-2120A | JW-2012C JW-2012A | JW-2014C JW-2014A | JW-2016C JW-2016A | JW-2022C JW-2022A |
|--------------------------|----------------------|----------------------|----------------------|----------------------|----------------------|----------------------|----------------------|----------------------|
| Top Dia(cm) | 6 | 6.8 | 7.1 | 7.6 | 8.6 | 8.3 | 8.4 | 8.9 |
| Bottom Dia(cm) | 4.6 | 4.9 | 5.5 | 5.8 | 7.3 | 6.4 | 6.4 | 6.7 |
| Height(cm) | 9 | 11.3 | 12.2 | 12.8 | 9.5 | 12.4 | 14 | 17 |
| Capacity(ml/oz) | 182/5.8 | 284/9.1 | 307/9.9 | 355/11.4 | 355/11.4 | 410/13.2 | 480/15.4 | 695/22.3 |
| Material | PC/AS | PC/AS | PC/AS | PC/AS | PC/AS | PC/AS | PC/AS | PC/AS |
| Colour | Clear | Clear | Clear | Clear | Clear | Clear | Clear | Clear |
| PCS/CTN | 72 | 72 | 72 | 72 | 72 | 72 | 72 | 72 |

Note: This item requires a MOQ 3000pcs.

Beverage Tumblers

Classic Leopard Grain Tumblers

- Attractive panel and facet design
- Made of break-resistant polycarbonate or durable SAN, safe and sanitary
- Ideal for outdoor recreation places, clubs or homes



| PC Art.No. AS Art.No. | JW-3008C JW-3008A | JW-3010C JW-3010A | JW-3012C JW-3012A | JW-3014C JW-3014A | JW-3015C JW-3015A | JW-3022C JW-3022A |
|--------------------------|----------------------|----------------------|----------------------|----------------------|----------------------|----------------------|
| Top Dia(cm) | 6.9 | 7.4 | 7.9 | 8.3 | 8.4 | 9.3 |
| Bottom Dia(cm) | 5.3 | 5.4 | 5.6 | 5.9 | 6.3 | 6.9 |
| Height(cm) | 10.9 | 12.1 | 12.7 | 13.1 | 14 | 15.4 |
| Capacity(ml/oz) | 240/7.7 | 198/9.65 | 368/11.8 | 420/13.5 | 452/14.6 | 655/21.1 |
| Material | PC/AS | PC/AS | PC/AS | PC/AS | PC/AS | PC/AS |
| Colour | Clear | Clear | Clear | Clear | Clear | Clear |
| PCS/CTN | 72 | 72 | 72 | 72 | 72 | 72 |

Note: This item requires a MOQ 3000pcs.

Watermark Round Base Tumblers

- Attractive pebbled exterior hides scratches, easy for hold.
- Made of environmental material, safe and sanitary.



| PC Art.No. AS Art.No. | JW-4005C JW-4005A | JW-4008C JW-4008A | JW-4009C JW-4009A | JW-4010C JW-4010A | JW-4011C JW-4011A | JW-4012C JW-4012A | JW-4015C JW-4015A |
|--------------------------|----------------------|----------------------|----------------------|----------------------|----------------------|----------------------|----------------------|
| Top Dia(cm) | 5.4 | 6.2 | 6.4 | 6.5 | 7 | 7 | 7.5 |
| Bottom Dia(cm) | 4.8 | 5.6 | 5.9 | 5.8 | 6.4 | 6.4 | 6.7 |
| Height(cm) | 9.5 | 11.1 | 11.8 | 11.5 | 12.3 | 12.9 | 14 |
| Capacity(ml/oz) | 158/5.1 | 248/8.0 | 280/9.0 | 289/9.3 | 358/11.5 | 373/12 | 466/15 |
| Material | PC/AS | PC/AS | PC/AS | PC/AS | PC/AS | PC/AS | PC/AS |
| Colour | Clear | Clear | Clear | Clear | Clear | Clear | Clear |
| PCS/CTN | 72 | 72 | 72 | 72 | 72 | 72 | 72 |

Note: This item requires a MOQ 3000pcs.

Juice Tumblers

- Made of break-resistant polycarbonate or durable SAN material, easy to clean and store

| PC Art.No. AS Art.No. | JW-1220C JW-1220A | JW-1216C JW-1216A |
|--------------------------|----------------------|----------------------|
| Top Dia(cm) | 8.8 | 9 |
| Bottom Dia(cm) | 6.2 | 6.8 |
| Height(cm) | 16 | 13 |
| Capacity(ml/oz) | 530/17 | 485/15.6 |
| Material | PC/AS | PC/AS |
| Colour | Clear | Clear |
| PCS/CTN | 72 | 72 |

Note: This item requires a MOQ 3000pcs.



JW-1220C
JW-1220A

JW-1216C
JW-1216A

Beverage Tumblers

Beverage Tumblers

- Made of durable polycarbonate or SAN material.
- Environment-friendly, break-resistant, sanitary and long lasting.
- Stacking lugs prevent jamming when stored.
- Ideal for schools, hospitals and chain restaurants.



| PC Art.No. AS Art.No. | JW-5050C JW-5050A | JW-5080C JW-5080A | JW-5085C JW-5085A | JW-5095C JW-5095A | JW-5120C JW-5120A | JW-5160C JW-5160A |
|--------------------------|----------------------|----------------------|----------------------|----------------------|----------------------|----------------------|
| Top Dia(cm) | 5.7 | 6.7 | 8.6 | 7 | 7.5 | 7.9 |
| Bottom Dia(cm) | 4.4 | 5.1 | 5.4 | 5.4 | 5.7 | 6 |
| Height(cm) | 9.2 | 10.2 | 9.7 | 11.1 | 13.2 | 14.7 |
| Capacity(ml/oz) | 154/5 | 230/7.4 | 320/10.3 | 275/8.9 | 455/14.6 | 460/14.9 |
| Material | PC/AS | PC/AS | PC/AS | PC/AS | PC/AS | PC/AS |
| Colour | Clear | Clear | Clear | Clear | Clear | Clear |
| PCS/CTN | 72 | 72 | 72 | 72 | 72 | 72 |

Note: This item requires a MOQ 3000pcs.

Concave Base Tumblers

- Made of durable polycarbonate or economical impact resistant SAN.
- Textured body prevents scratches.
- Ideal for bar, poolside and tabletop service.



| PC Art.No. AS Art.No. | JW-6050C JW-6050A | JW-6080C JW-6080A | JW-6090C JW-6090A | JW-6095C JW-6095A | JW-6120C JW-6120A | JW-6160C JW-6160A | JW-6210C JW-6210A | JW-6310C JW-6310A |
|--------------------------|----------------------|----------------------|----------------------|----------------------|----------------------|----------------------|----------------------|----------------------|
| Top Dia(cm) | 5.7 | 6.7 | 8.1 | 7 | 7.5 | 7.9 | 8.6 | 10 |
| Bottom Dia(cm) | 4.4 | 5.1 | 6.35 | 5.4 | 5.7 | 6 | 6.35 | 7.3 |
| Height(cm) | 9.2 | 10.2 | 8.3 | 11.1 | 13.2 | 14.6 | 16.5 | 18.2 |
| Capacity(ml/oz) | 154/5 | 231/7.4 | 287/9.2 | 290/9.3 | 373/12 | 485/15.6 | 650/20.9 | 976/31.4 |
| Material | PC/AS | PC/AS | PC/AS | PC/AS | PC/AS | PC/AS | PC/AS | PC/AS |
| Colour | Clear | Clear | Clear | Clear | Clear | Clear | Clear | Clear |
| PCS/CTN | 72 | 72 | 72 | 72 | 72 | 72 | 72 | 72 |

Note: This item requires a MOQ 3000pcs.

Propitious Flat Base Tumblers & Pleasant Wide-mouth Tumblers

- Bright color follows up with people's color references
- Frosted surface avoids to be scraped
- Stacking lugs prevent jamming when stored
- Ideal for homes, schools and chain restaurants



| Art.No. | JW-8010P | JW-8013P | JW-8016P | JW-1110P | JW-1113P |
|-----------------|-------------|-------------|-------------|-------------|-------------|
| Top Dia(cm) | 6.8 | 7.5 | 7.9 | 8.1 | 8.7 |
| Bottom Dia(cm) | 5.5 | 6.2 | 6.3 | 5.5 | 5.6 |
| Height(cm) | 11.2 | 12 | 13.8 | 9.4 | 11.7 |
| Capacity(ml/oz) | 280/9 | 390/12.6 | 480/15.5 | 290/9.3 | 405/13 |
| Material | PP | PP | PP | PP | PP |
| Colour | Blue/Orange | Blue/Orange | Blue/Orange | Blue/Orange | Blue/Orange |
| PCS/CTN | 72 | 72 | 72 | 72 | 72 |

Note: This item requires a MOQ 3000pcs.

Beverage Tumblers

Textured Flat Base Tumblers

- Made of unbreakable polycarbonate or impact resistant SAN.
- Elegant design and textured body feature the tumbler a good deal of drink service.



| PC Art.No. AS Art.No. | JW-9010C JW-9010A | JW-9011C JW-9011A | JW-9012C JW-9012A | JW-9013C JW-9013A |
|--------------------------|----------------------|----------------------|----------------------|----------------------|
| Top Dia(cm) | 8.1 | 8.5 | 8 | 8.1 |
| Bottom Dia(cm) | 5.7 | 5.7 | 5.1 | 5.8 |
| Height(cm) | 12.0 | 11.4 | 12.8 | 13.7 |
| Capacity(ml/oz) | 290/10.5 | 370/11.9 | 380/12.2 | 410/13.2 |
| Material | PC/AS | PC/AS | PC/AS | PC/AS |
| Colour | Clear | Clear | Clear | Clear |
| PCS/CTN | 72 | 72 | 72 | 72 |

Note: This item requires a MOQ 3000pcs.

Square Base Drinking Tumblers

- Made of super-clear polycarbonate or impact resistant SAN, sanitary and lightweight.
- The thick base adds the stability.
- Ideal for drinking service.



| PC Art.No. AS Art.No. | JW-1308C JW-1308A | JW-1310C JW-1310A | JW-1311C JW-1311A | JW-1312C JW-1312A | JW-1314C JW-1314A |
|--------------------------|----------------------|----------------------|----------------------|----------------------|----------------------|
| Top Dia(cm) | 6.5 | 8.3 | 7.6 | 7.2 | 8.5 |
| Bottom Dia(cm) | 4.2 | 5.1 | 4.9 | 4.8 | 6.6 |
| Height(cm) | 12 | 9.5 | 14 | 14.5 | 12 |
| Capacity(ml/oz) | 224/7.2 | 358/11.5 | 363/11.7 | 372/12 | 425/13.7 |
| Material | PC/AS | PC/AS | PC/AS | PC/AS | PC/AS |
| Colour | Clear | Clear | Clear | Clear | Clear |
| PCS/CTN | 36 | 72 | 36 | 36 | 72 |

Note: This item requires a MOQ 3000pcs.

Textured Drinking Tumblers

- Made of transparent polycarbonate or impact resistant SAN, it is lightweight and sanitary.
- Textured body prevents scratches.
- deal for restaurants, schools or homes.



| PC Art.No. AS Art.No. | JW-7009C JW-7009A | JW-7011C JW-7011A | JW-7015C JW-7015A | JW-7016C JW-7016A | JW-7024C JW-7024A |
|--------------------------|----------------------|----------------------|----------------------|----------------------|----------------------|
| Top Dia(cm) | 6.7 | 7.5 | 9.7 | 7.8 | 8.8 |
| Bottom Dia(cm) | 5.1 | 6 | 8.3 | 6 | 7.2 |
| Height(cm) | 10.6 | 10.6 | 8.3 | 15.1 | 16.8 |
| Capacity(ml/oz) | 265/8.5 | 331/10.7 | 463/14.9 | 498/16.0 | 743/23.9 |
| Material | PC/AS | PC/AS | PC/AS | PC/AS | PC/AS |
| Colour | Clear | Clear | Clear | Clear | Clear |
| PCS/CTN | 72 | 72 | 72 | 72 | 72 |

Note: This item requires a MOQ 3000pcs.



Beverage Tumblers

Mark Beer Tumblers

- Made of unbreakable polycarbonate.
- A wide and easy-grip handle ensures a quick drying and applies to dishwasher.
- Ideal for serving beer, tea or soda on table service.



| Art.No. | JW-1815C | JW-1820C | JW-1821C | JW-1812C | JW-1813C |
|-----------------|----------|----------|----------|----------|----------|
| Top Dia(cm) | 8.6 | 9.5 | 9.5 | 7.3 | 8.9 |
| Bottom Dia(cm) | 7.9 | 6.8 | 7.5 | 6.6 | 5.5 |
| Height(cm) | 11.2 | 12 | 12.7 | 13 | 14.3 |
| Capacity(ml/oz) | 455/14.6 | 605/19.5 | 630/20.3 | 365/11.7 | 410/13.2 |
| Max Lenght | 11.2 | 13.5 | 13 | 10.5 | 11.7 |
| Material | PC | PC | PC | PC | PC |
| Colour | Clear | Clear | Clear | Clear | Clear |
| PCS/CTN | 36 | 36 | 24 | 24 | 36 |

Note: This item requires a MOQ 3000pcs.

Thick Base Beer Tumblers

- Made of unbreakable polycarbonate or impact resistant SAN.
- Elegant design and lightweight construction allows for an easy handle.
- Ideal for bars, hotels and clubs.



| PC Art.No. AS Art.No. | JW-1708C JW-1708A | JW-1710C JW-1710A | JW-1711C JW-1711A | JW-1712C JW-1712A | JW-1713C JW-1713A | JW-1714C JW-1714A |
|--------------------------|----------------------|----------------------|----------------------|----------------------|----------------------|----------------------|
| Top Dia(cm) | 7.2 | 7.9 | 7.7 | 7.9 | 8.4 | 7 |
| Bottom Dia(cm) | 5.7 | 5.8 | 6 | 6 | 7.2 | 5.9 |
| Height(cm) | 12.6 | 18 | 13.8 | 12.6 | 13 | 16.5 |
| Capacity(ml/oz) | 250/8 | 310/10 | 340/10.9 | 360/11.6 | 390/12.5 | 340/10.9 |
| Material | PC/AS | PC/AS | PC/AS | PC/AS | PC/AS | PC/AS |
| Colour | Clear | Clear | Clear | Clear | Clear | Clear |
| PCS/CTN | 36 | 36 | 36 | 36 | 36 | 36 |

Note: This item requires a MOQ 3000pcs.

Beverage Tumblers

Round Base Drinking Tumblers

- Made of super-clear polycarbonate or impact resistant SAN, sanitary and lightweight.
- A low cost of replacement is ensured as well.
- Ideal for drinking service.



| PC Art.No. AS Art.No. | JW-1611C JW-1611A | JW-1613C JW-1613A | JW-1615C JW-1615A | JW-1616C JW-1616A | JW-1618C JW-1618A |
|--------------------------|----------------------|----------------------|----------------------|----------------------|----------------------|
| Top Dia(cm) | 8 | 7.4 | 7.4 | 8.2 | 8.8 |
| Bottom Dia(cm) | 5.4 | 5.7 | 6.8 | 5.5 | 5.7 |
| Height(cm) | 13.5 | 13.7 | 13.8 | 15 | 15.4 |
| Capacity(ml/oz) | 350/11.3 | 420/13.5 | 465/15 | 490/15.8 | 565/18.2 |
| Material | PC/AS | PC/AS | PC/AS | PC/AS | PC/AS |
| Colour | Clear | Clear | Clear | Clear | Clear |
| PCS/CTN | 36 | 36 | 36 | 36 | 36 |

Note: This item requires a MOQ 3000pcs.

Thick Base Tumblers

- Made of unbreakable polycarbonate or impact resistant SAN for a safe drinking
- Designed with a thick base, providing a good stability.
- Ideal for restaurant service, bar service or poolside service.



| PC Art.No. AS Art.No. | JW-1512C JW-1512A | JW-1513C JW-1513A | JW-1514C JW-1514A | JW-1515C JW-1515A | JW-1518C JW-1518A |
|--------------------------|----------------------|----------------------|----------------------|----------------------|----------------------|
| Top Dia(cm) | 8.2 | 8 | 7.3 | 8.2 | 8.1 |
| Bottom Dia(cm) | 5.3 | 6 | 6.2 | 6.1 | 6 |
| Height(cm) | 15.2 | 16.9 | 18.2 | 18 | 16 |
| Capacity(ml/oz) | 488/16 | 410/13.2 | 435/14 | 480/15.4 | 560/18 |
| Material | PC/AS | PC/AS | PC/AS | PC/AS | PC/AS |
| Colour | Clear | Clear | Clear | Clear | Clear |
| PCS/CTN | 36 | 36 | 36 | 36 | 36 |

Note: This item requires a MOQ 3000pcs.

Polygon Base Tumblers

- Unbreakable polycarbonate or impact resistant SAN ensures a sanitary drinking and a low replacement cost.
- A wide mouth provides an easy washing.
- Ideal for drinking service.

| PC Art.No. AS Art.No. | JW-1411C JW-1411A | JW-2313C JW-2313A |
|--------------------------|----------------------|----------------------|
| Top Dia(cm) | 7.4 | 8 |
| Bottom Dia(cm) | 5.9 | 7.7 |
| Height(cm) | 12.1 | 19 |
| Capacity(ml/oz) | 355/11.4 | 420/13.5 |
| Material | PC/AS | PC/AS |
| Colour | Clear | Clear |
| PCS/CTN | 72 | 24 |

Note: This item requires a MOQ 3000pcs.

V-Base Beer Tumblers

- Made of super-clear polycarbonate or impact resistant SAN.
- Designed with a tapered body, allow easy pouring.
- Suit for beverage with alcohol less than 75%.



JW-1411C
JW-1411A

JW-2313C
JW-2313A

Beverage Tumblers

Stem Tumblers

- Made of super-clear, anti-breakage polycarbonate.
- A durable tumbler for bar service, room service or poolside service.



| Art.No. | JW-2103C | JW-2105C | JW-2111C | JW-2115C |
|-----------------|----------|----------|----------|----------|
| Top Dia(cm) | 5.2 | 6.8 | 7.9 | 8.9 |
| Bottom Dia(cm) | 6.6 | 6.6 | 7.7 | 8.2 |
| Height(cm) | 18. 8 | 13. 5 | 18. 3 | 17. 8 |
| Capacity(ml/oz) | 156/5 | 175/5.6 | 340/11 | 480/154 |
| Material | PC | PC | PC | PC |
| Colour | Clear | Clear | Clear | Clear |
| PCS/CTN | 36 | 36 | 36 | 36 |

Note: This item requires a MOQ 3000pcs.

Ice Cream Tumblers

- Made of super-clear and durable polycarbonate.
- An excellent choice for poolside and other outdoor events that requires break resistance.



| Art.No. | JW-2205C | JW-2206C | JW-2207C |
|-----------------|----------|----------|----------|
| Top Dia(cm) | 10 | 9.9 | 10 |
| Bottom Dia(cm) | 6.8 | 6.7 | 6.8 |
| Height(cm) | 9. 3 | 9 | 13. 8 |
| Capacity(ml/oz) | 170/5.5 | 215/6.9 | 220/7.1 |
| Material | PC | PC | PC |
| Colour | Clear | Clear | Clear |
| PCS/CTN | 36 | 36 | 36 |

Note: This item requires a MOQ 3000pcs.

Fast Food Tray

Fast Food Tray

- Made of high strength ABS or heat resistant polypropylene.
- With unique non-slip design, it can minimize the food wasting.
- Ideal for schools, restaurants and fast-food chains.
- It is not suggested to use in heating insulated cart.



JW-A1014

JW-A1218

JW-A1216



JW-E1218

JW-D1217



JW-B1115

JW-A1418

| PP Art.No. | JW-A1014P | JW-A1216P | JW-A1218P | JW-A1418P | JW-B1115P | JW-D1217P | JW-E1218P |
|--------------|------------------|------------------|------------------|------------------|------------------|------------------|------------------|
| ABS Art.No. | JW-A1014A | JW-A1216A | JW-A1218A | JW-A1418A | JW-B1115A | JW-D1217A | JW-E1218A |
| Overall size | 345x263 mm | 415x300 mm | 455x300 mm | 455x355 mm | 380x280 mm | 425x300 mm | 450x305 mm |
| Height | 20 mm | 20 mm | 20 mm | 18.5 mm | 21 mm | 32 mm | 27 mm |
| Capacity | 320x230 mm | 380x270 mm | 400x270 mm | 420x320 mm | 340x240 mm | 360x280 mm | 420x270 mm |
| Material | PP/ABS | PP/ABS | PP/ABS | PP/ABS | PP/ABS | PP/ABS | PP/ABS |
| Colour | Coffee/Red/Black | Coffee/Red/Black | Coffee/Red/Black | Coffee/Red/Black | Coffee/Red/Black | Coffee/Red/Black | Coffee/Red/Black |
| PCS/CTN | 24 | 24 | 24 | 24 | 24 | 24 | 24 |

Non-slip Tray Series

- Made of ABS and TPR
- Surface frosted, Soft non-slip anti-skid tableware
- Lightweight construction and shatterproof textures minimize the labor for service and replacement cost.
- Suitable for restaurant, bar, nightclub and coffee shop.

| | |
|----------|----------------------|
| Art.No. | JW-FC1060 |
| Name | Non-slip Tray Series |
| Material | ABS/TPR |
| Colour | Coffee/Black/White |
| Size | 420x315 mm |
| PCS/CTN | 12 |



NEW!

Fast Food Tray

PP Non-slip Tray Series

- Made of heat resistant polypropylene.
- Rubber surface can prevent tableware from slipping.
- Lightweight construction and shatterproof textures minimize the labor for service and replacement cost.
- Suitable for restaurant, bar, nightclub and coffee shop.

Material: PP
Colour: Brown/Black



| | | | |
|---------|----------------------|----------------------|----------------------|
| Art.No. | JW-R1100P | JW-R1400P | JW-R1600P |
| Name | Round Anti-Skid Tray | Round Anti-Skid Tray | Round Anti-Skid Tray |
| Size | Φ280x20 mm | Φ355x22 mm | Φ405x22 mm |
| PCS/CTN | 12 | 12 | 12 |

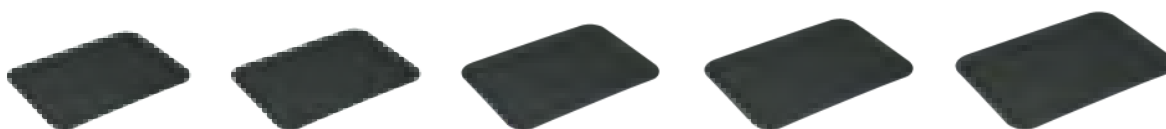

| | | | | | |
|---------|----------------------------|----------------------------|----------------------------|----------------------------|----------------------------|
| Art.No. | JW-R1014P | JW-R1216P | JW-R1418P | JW-R1520P | JW-R1622P |
| Name | Rectangular Anti-Skid Tray | Rectangular Anti-Skid Tray | Rectangular Anti-Skid Tray | Rectangular Anti-Skid Tray | Rectangular Anti-Skid Tray |
| Size | 354x255x22.5 mm | 409x299x20 mm | 457x355x22 mm | 507x380x22 mm | 558x405x22 mm |
| PCS/CTN | 12 | 12 | 12 | 12 | 12 |

Fiberglass Non-slip Tray Series

- Made of durable fiberglass.
- Glass fiber layer and the rubber layer solidified into a whole.
- High impact resistance and anti-deformation.
- Resistant to 120°C (248°F)

Material: Fiberglass
Colour: Brown/Black



| | | | | | |
|---------|----------------------|----------------------|----------------------|----------------------|----------------------------|
| Art.No. | JW-R1100CT | JW-R1400CT | JW-R1600CT | JW-R1800CT | JW-R1014CT |
| Name | Round Anti-Skid Tray | Round Anti-Skid Tray | Round Anti-Skid Tray | Round Anti-Skid Tray | Rectangular Anti-Skid Tray |
| Size | Φ280x20 mm | Φ355x22.5 mm | Φ405x22 mm | Φ460x22 mm | 350x270 mm |
| PCS/CTN | 12 | 12 | 12 | 12 | 12 |



| | | | | | |
|---------|----------------------------|----------------------------|----------------------------|----------------------------|----------------------------|
| Art.No. | JW-R1216CT | JW-R1418CT | JW-R1520CT | JW-R1622CT | JW-R1826CT |
| Name | Rectangular Anti-Skid Tray | Rectangular Anti-Skid Tray | Rectangular Anti-Skid Tray | Rectangular Anti-Skid Tray | Rectangular Anti-Skid Tray |
| Size | 415x305 mm | 460x355 mm | 515x380 mm | 560x405 mm | 650x450 mm |
| PCS/CTN | 12 | 12 | 12 | 12 | 6 |



| | | | | | |
|---------|----------------------------|---------------------|---------------------|---------------------|---------------------|
| Art.No. | JW-R3020CT | JW-R2500CT | JW-R2700CT | JW-R2900CT | JW-R3100CT |
| Name | Rectangular Anti-Skid Tray | Oval Anti-Skid Tray | Oval Anti-Skid Tray | Oval Anti-Skid Tray | Oval Anti-Skid Tray |
| Size | 750x480 mm | 640x490 mm | 685x560 mm | 735x600 mm | 800x600 mm |
| PCS/CTN | 6 | 12 | 6 | 6 | 6 |

Buffetwares

Crocks

- Made of durable SAN.
- Resistant to stains, impact and food acids.
- Highly glossy surface ensures them a good ideal for buffets or sandwich shops.



| Art.No. | P-041 | P-042 | P-043 |
|----------|-----------------------|-----------------------|-----------------------|
| Name | Small Crock | Medium Crock | Big Crock |
| Size | 157x127x82 mm | 263x172x82 mm | 333x264x82 mm |
| Colour | Clear/Red/Black/White | Clear/Red/Black/White | Clear/Red/Black/White |
| Material | AS | AS | AS |
| PCS/CTN | 48 | 24 | 12 |

Lids



| Art.No. | P-042A | P-043A |
|----------|---------------|---------------|
| Name | Medium Lid | Big Lid |
| Size | 237x149x35 mm | 310x239x35 mm |
| Colour | Clear | Clear |
| Material | PC/AS | PC/AS |
| PCS/CTN | 48 | 48 |



Swirl Bowl

- Made of durable polycarbonate.
- Beautiful swirl pattern makes the bowl ideal for serving fruits, salads, sauces and ice creams.
- 148ml and 384ml are available.



| Art.No. | P-001 | P-002 |
|----------|-------------------|-------------------|
| Name | Small Swirl Bowl | Big Swirl Bowl |
| Size | Φ91x62 mm | Φ130.3x61 mm |
| Capacity | 148ML | 384ML |
| Colour | PC | PC |
| Material | Clear/White/Black | Clear/White/Black |
| PCS/CTN | 72 | 72 |



Buffetwares

Ladles



- Made of anti-breakage polycarbonate.
- Designed with an angled handle to avoid the ladle to slip into bowls.
- Portion control helps to serve the perfect amount of dressing or food ingredient.



| Art.No. | P-012 | P-013 | P-014 |
|----------|-----------------------|-----------------------|-----------------------|
| Name | Small Ladle | Medium Ladle | Big Ladle |
| Size | 210mm/8.5" | 268 mm/10.5" | 330 mm/13" |
| Capacity | 25ml | 30ml | 30ml |
| Materia | PC | PC | PC |
| Colour | Clear/Red/Beige/Black | Clear/Red/Beige/Black | Clear/Red/Beige/Black |
| CPCS/CTN | 72 | 72 | 72 |

Note: Red requires a MOQ.



Serving Spoon



- Made of unbreakable polycarbonate.
- Lightweight and super tough construction makes no cracks, no dents and no rust.
- Featured with a notched back and a handle slot for easy rest or hanging.

Perforated Spoon



| Art.No. | P-015 | P-017 |
|---------|------------------------|-----------------------|
| Name | Small Perforated Spoon | Big Perforated Spoon |
| Size | 283x73 mm/11x2.9" | 333x73 mm/13x2.9" |
| Materia | PC | PC |
| Colour | Clear/Red/Beige/Black | Clear/Red/Beige/Black |
| PCS/CTN | 72 | 72 |

Note: Red requires a MOQ.

Solid Spoon



| Art.No. | P-016 | P-018 |
|---------|-----------------------|-----------------------|
| Name | Small Solid Spoon | Big Solid Spoon |
| Size | 283x73 mm/11x2.9" | 333x73 mm/13x2.9" |
| Materia | PC | PC |
| Colour | Clear/Red/Beige/Black | Clear/Red/Beige/Black |
| PCS/CTN | 72 | 72 |

Note: Red requires a MOQ.

Serving Spoon



| Art.No. | P-003 | P-004 | P-005 |
|---------|-----------------------|-----------------------|-----------------------|
| Name | Small Serving Spoon | Serving Spoon | Big Serving Spoon |
| Size | 206x38 mm/8x1.5" | 260x43 mm/10x1.7" | 260x43 mm/10x1.7" |
| Materia | PC | PC | PC |
| Colour | Clear/Red/Beige/Black | Clear/Red/Beige/Black | Clear/Red/Beige/Black |
| PCS/CTN | 72 | 72 | 72 |

Note: Red requires a MOQ.



Buffetwares

Tongs

- Made of anti-breakage polycarbonate.
- The flat tong is ribbed to ensure a secure hold.
- The scallop tong features an ergonomic design for a secure grip of items that are hard to hold.



| Art.No. | P-006 | P-007 | P-008 |
|---------|-----------------------|-----------------------|-----------------------|
| Name | Small Flat Tong | Medium Flat Tong | Big Flat Tong |
| Size | 150mm/6" | 230mm/9" | 305mm/12" |
| Materia | PC | PC | PC |
| Colour | Clear/Red/Beige/Black | Clear/Red/Beige/Black | Clear/Red/Beige/Black |
| PCS/CTN | 72 | 72 | 72 |

Note: Red requires a MOQ.



| Art.No. | P-009 | P-010 | P-011 |
|---------|-----------------------|-----------------------|-----------------------|
| Name | Small Scallop Tong | Medium Scallop Tong | Big Scallop Tong |
| Size | 150mm/6" | 230mm/9" | 305mm/12" |
| Materia | PC | PC | PC |
| Colour | Clear/Red/Beige/Black | Clear/Red/Beige/Black | Clear/Red/Beige/Black |
| PCS/CTN | 72 | 72 | 72 |

Note: Red requires a MOQ.



Food Tongs

- Made of break resistant polycarbonate and good quality stainless steel.
- Streamline body provides an easy-cleaning.
- Scalloped edges serve a secure grip for items that are hard to hold.



| Art.No. | P-050 |
|---------|------------|
| Name | Food Tongs |
| Size | 215 mm |
| Materia | PC |
| Colour | Clear |
| PCS/CTN | 96 |

Salad Clip

- Made of PC material, it is firm and durable.
- Safe and hygienic, it meets request of NSF design.
- Ideal for buffets, restaurants or hotels.

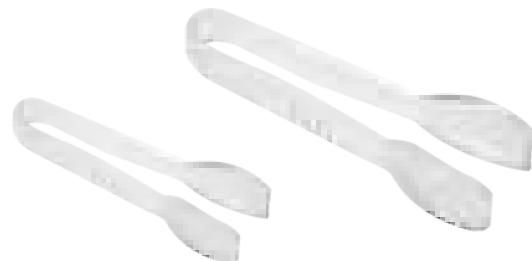

| Art.No. | JW-SL06 | JW-SL09 |
|---------|---------------|---------------|
| Name | 6" Salad Clip | 9" Salad Clip |
| Size | 160 mm/6.5" | 230 mm/9" |
| Materia | PC | PC |
| Colour | Clear | Clear |
| PCS/CTN | 72 | 72 |

Buffetwares

Condiment Jars

- Made of clear, break-resistant polycarbonate.
- Lids are slotted for serving spoons.
- Designed to hold condiments like mustard, ketchup, dressings etc.

| | |
|----------|----------------|
| Art.No. | JW-CJ250 |
| Name | Condiment Jars |
| Size | 84x104mm |
| Capacity | 250ml |
| Material | PC |
| Colour | Clear |
| PCS/CTN | 24 |



Dredges

- Made of clear, unbreakable polycarbonate.
- Can be cleaned in the dishwasher.
- It's easy to identify the condiments with lids in different colours.
- A staple in the kitchen or on the dining table.



| | | | | | | |
|----------|---------------------------------|---|---|---------------------------------------|----------------------------------|-----------------------------------|
| Art.No. | JW-SK280N | JW-SK280M | JW-SK280D | JW-SK280F | JW-SK280C | JW-SK280P |
| Name | Shakers Complete With Solid Lid | Shakers Complete With Medium Ground Lid | Shakers Complete With Salt & Pepper Lid | Shakers Complete With Fine Ground Lid | Shakers Complete With Cheese Lid | Shakers Complete With Parsley Lid |
| Size | 110x80x97mm | 110x80x97mm | 110x80x97mm | 110x80x97mm | 110x80x97mm | 110x80x97mm |
| Capacity | 280ml | 280ml | 280ml | 280ml | 280ml | 280ml |
| Material | PC+PE | PC+PE | PC+PE | PC+PE | PC+PE | PC+PE |
| Colour | Clear | Clear | Clear | Clear | Clear | Clear |
| PCS/CTN | 24 | 24 | 24 | 24 | 24 | 24 |

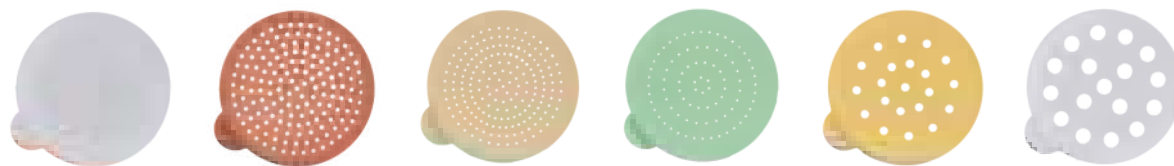

| | | | | | | |
|----------|------------|-------------------|-------------------|-----------------|------------|-------------|
| Art.No. | JW-SK280LN | JW-SK280LM | JW-SK280LD | JW-SK280LF | JW-SK280LC | JW-SK280LP |
| Name | Solid Lid | Medium Ground Lid | Salt & Pepper Lid | Fine Ground Lid | Cheese Lid | Parsley Lid |
| Size | 80x10mm | 80x10mm | 80x10mm | 80x10mm | 80x10mm | 110x80x97mm |
| Material | PE | PE | PE | PE | PE | PE |
| Colour | White | Rose | Beige | Green | Yellow | White |
| PCS/CTN | 72 | 72 | 72 | 72 | 72 | 72 |

Buffetwares

Rectangular Pebbled Bowl

- Made of clear ,anti-breakage polycarbonate.
- Featured a textured body for an elegant look and to avoid scratches.
- Ideal for food display in buffets, hotels or parties.



| Art.No. | JW-W1290C | JW-W1511C |
|----------|--------------------------------|------------------------------|
| Name | Small Rectangular Pebbled Bowl | Big Rectangular Pebbled Bowl |
| Size | 305x227x60 mm | 370x270x70 mm |
| Capacity | 2250ml | 3000ml |
| Material | PC | PC |
| Colour | Clear | Clear |
| PCS/CTN | 36 | 24 |

Note: This item requires a MOQ.

Round Salad Bowl

- Made of anti-breakage polycarbonate or impact resistant AS.
- Clear and elegant appearance is very suitable for food display and table service.

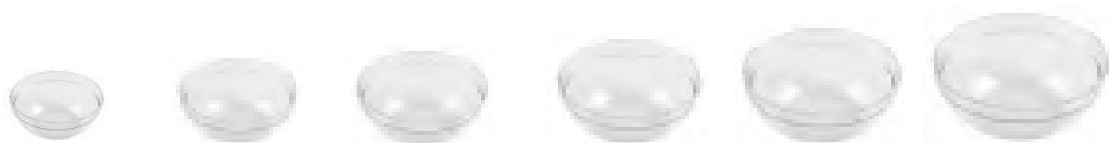

| PC Art.No. | JW-W500C | JW-W600C | JW-W700C | JW-W800C | JW-W900C | JW-W1000C |
|------------|------------------|------------------|------------------|------------------|------------------|------------------|
| AS Art.No. | JW-W500A | JW-W600A | JW-W700A | JW-W800A | JW-W900A | JW-W1000A |
| Name | Round Salad Bowl | Round Salad Bowl | Round Salad Bowl | Round Salad Bowl | Round Salad Bowl | Round Salad Bowl |
| Size | Φ120x55mm | Φ140x65mm | Φ170x75mm | Φ200x90mm | Φ230x100mm | Φ260x110mm |
| Capacity | 300ml | 450ml | 700ml | 1250ml | 2000ml | 3000ml |
| Material | PC/AS | PC/AS | PC/AS | PC/AS | PC/AS | PC/AS |
| Colour | Clear | Clear | Clear | Clear | Clear | Clear |
| PCS/CTN | 48 | 48 | 48 | 24 | 24 | 24 |

Note: This item requires a MOQ.

Buffetwares

Round Pebbled Bowls

- Made of clear and anti-breakage polycarbonate.
- Textured body features with a stylish appearance and scratch resistance.
- A ideal for buffet, hotel or party service.



| Art.No. | JW-S1000C | JW-S1200C | JW-S1500C | JW-S1800C |
|----------|---------------------|---------------------|---------------------|---------------------|
| Name | Round Pebbled Bowls | Round Pebbled Bowls | Round Pebbled Bowls | Round Pebbled Bowls |
| Size | Φ260x100 mm | Φ300x110 mm | Φ375x135 mm | Φ445x140 mm |
| Capacity | 3000ml | 4750ml | 9750ml | 14800ml |
| Material | PC | PC | PC | PC |
| Colour | Clear | Clear | Clear | Clear |
| PCS/CTN | 48 | 48 | 24 | 12 |

Note: This item requires a MOQ.

Square Salad Bowls

- Made of unbreakable polycarbonate.
- Elegant design provides good ideal for salad storage or table service.



| Art.No. | JW-SSB60 | JW-SSB80 | JW-SSB100 | JW-SSB115 |
|----------|--------------------|--------------------|--------------------|--------------------|
| Name | Square Salad Bowls | Square Salad Bowls | Square Salad Bowls | Square Salad Bowls |
| Size | 125x125x60 mm | 140x140x80 mm | 190x190x100 mm | 240x240x115 mm |
| Capacity | 300ml | 550ml | 1200ml | 2500ml |
| Material | PC | PC | PC | PC |
| Colour | White | White | White | White |
| PCS/CTN | 48 | 24 | 24 | 24 |

Note: This item requires a MOQ.

Buffetwares

Food Cover

- Made of unbreakable polycarbonate, transparent and attractive.
- Compared to metal, PC covers are lighter and with better insulation effect.
- Featured with rust-resistant, easy-cleaning and no need for preheating.



| Art.No. | JW-8RP | JW-9RP | JW-10RP | JW-11RP | JW-12RP | JW-14RP |
|----------|-------------------------|-------------------------|--------------------------|--------------------------|--------------------------|--------------------------|
| Name | 8-Inch Round Food Cover | 9-Inch Round Food Cover | 10-Inch Round Food Cover | 11-Inch Round Food Cover | 12-Inch Round Food Cover | 14-Inch Round Food Cover |
| Size | Φ214x214mm | Φ239x239mm | Φ264x264mm | Φ288x288mm | Φ315x315mm | Φ364x364mm |
| Outside | 65mm | 65mm | 64mm | 65mm | 63mm | 65mm |
| Material | PC | PC | PC | PC | PC | PC |
| Colour | Clear | Clear | Clear | Clear | Clear | Clear |
| PCS/CTN | 36 | 36 | 36 | 36 | 36 | 36 |

Note: This item requires a MOQ.

PC Cover

- Made of unbreakable polycarbonate.
- Light weight construction is unequalled in strength and durability.
- Heat and break resistant, can be used in insulated vans and can withstand high temperature up to 99°C(210°F)



| Art.No. | JW-10OP | JW-11OP | JW-12OP | JW-14OP |
|----------|------------------------|-------------------------|-------------------------|-------------------------|
| Name | 8-Inch Oval Food Cover | 11-Inch Oval Food Cover | 12-Inch Oval Food Cover | 14-Inch Oval Food Cover |
| Size | 262x195mm | 287x213mm | 313x237mm | 362x274mm |
| Outside | 65mm | 64mm | 64mm | 63mm |
| Material | PC | PC | PC | PC |
| Colour | Clear | Clear | Clear | Clear |
| PCS/CTN | 36 | 36 | 36 | 36 |

Note: This item requires a MOQ.

Plastic Barware

Dual-way First In First Out Squeeze Bottle

- Made of environmental, non-toxic PE with blow molding process.
- Designed with double wide mouth for easy cleaning and fast filling.
- Operating concept, First In First Out.
- Improving the utilization of sauce at least by 15%.
- Ideal for table or kitchen service.
- The temperature range is from -40°C to 80°C (47.2°F-176°F).

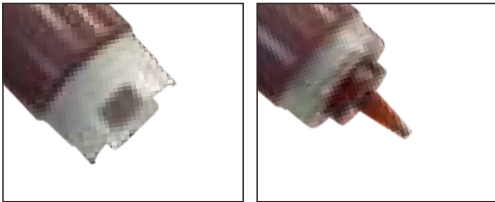

JW-FIFO12 JW-FIFO16 JW-FIFO20 JW-FIFO24 JW-FIFO32

| Art.No. | JW-FIFO12 | JW-FIFO16 | JW-FIFO20 | JW-FIFO24 | JW-FIFO32 |
|----------|--|--|--|--|--|
| Name | 12.oz Dual-way First In First Out Squeeze Bottle | 16.oz Dual-way First In First Out Squeeze Bottle | 20.oz Dual-way First In First Out Squeeze Bottle | 24.oz Dual-way First In First Out Squeeze Bottle | 32.oz Dual-way First In First Out Squeeze Bottle |
| Size | Φ62x167 mm | Φ62x208 mm | Φ70x208 mm | Φ75x208 mm | Φ87x208 mm |
| Capacity | 12.oz | 16.oz | 20.oz | 24.oz | 32.oz |
| Material | Translucent | Translucent | Translucent | Translucent | Translucent |
| PCS/CTN | 24 | 24 | 24 | 24 | 24 |

| Art.No. | JW-LC46 | JW-DC46 | JW-TC46 |
|---------|-------------|----------------------------|------------------------------|
| Name | Label Cap | Fifo Bottle Dispensing Cap | Precision Tip Dispensing Cap |
| Size | Φ52x15 mm | Φ57x31mm | Φ57x46 mm |
| Colour | Translucent | Translucent | Translucent |
| PCS/CTN | 64 | 64 | 64 |



Store'N Pour



| Art.No. | JW-BSP0.5 | JW-BSP1 | JW-BSP2 | JW-BSP2.5 |
|----------|--|--------------|--------------|--------------|
| Name | Store'N Pour | Store'N Pour | Store'N Pour | Store'N Pour |
| Size | Φ90x260 mm | Φ90x330 mm | Φ120x350 mm | Φ125x380 mm |
| Colour | Brown/Red/Yellow/Blue/Green/Oragne/White/Clear | | | |
| Capacity | 0.5L | 1.0L | 2.0L | 2.5L |
| Material | PP+AS+PE | PP+AS | PP+AS+PE | PP+AS+PE |
| PCS/CTN | 24 | 24 | 24 | 24 |

| Art.No. | JW-LBSD8 | JW-LBSD12 | JW-LBSD24 | JW-LBSD32 |
|----------|--------------------------------|--------------------------------|--------------------------------|--------------------------------|
| Name | Squeeze Dispenser (Wide Mouth) | Squeeze Dispenser (Wide Mouth) | Squeeze Dispenser (Wide Mouth) | Squeeze Dispenser (Wide Mouth) |
| Size | Φ50x178 mm | Φ60x196 mm | Φ70x253 mm | Φ70x325mm |
| Colour | Red/Yellow/White/Clear | | | |
| Capacity | 8oz. | 12oz. | 24oz. | 32oz. |
| Material | PP+PE | PP+PE | PP+PE | PP+PE |
| PCS/CTN | 240 | 240 | 240 | 120 |

Plastic Barware

1L New Free Puro

- Made of high-density polyethylene and polypropylene.
- Juice flows out from a hole at the top.
- The small hole can control the flowing speed of juice.
- The top can be easily held.
- The product is easy to clean.
- A registered design with practicalities in mind as opposed to just pouring or storing.



| | |
|----------|---------------------------------------|
| Art.No. | JW-BSNP1 |
| Name | 1L New Free Pour |
| Size | Φ97x333 mm |
| Capacity | 1L |
| Material | PE+PP |
| Colour | Red/Yellow/Blue Green/Orange /Primary |
| PCS/CTN | 24 |



| Art.No. | JW-B4B | JW-B6B | JW-B3B | JW-B5B |
|----------|--------------------------------|--------------------------------|--------------------------------|--------------------------------|
| Name | 4-Compartment Condiment Holder | 6-Compartment Condiment Holder | 3-Compartment Condiment Holder | 5-Compartment Condiment Holder |
| Size | 500x160x90 mm | 500x160x90 mm | 500x160x90 mm | 500x160x90 mm |
| Material | PC+PP+ABS | PC+PP+ABS | PC+PP+ABS | PC+PP+ABS |
| Colour | Clear/White/Black | Clear/White/Black | Clear/White/Black | Clear/White/Black |
| PCS/CTN | 12 | 12 | 12 | 12 |



| Art.No. | JW-BN6D | JW-BN3 | JW-BN6L |
|----------|-------------------------|-------------------------|------------------------|
| Name | 6-Deep Condiment Holder | 3-Deep Condiment Holder | 6-Low Condiment Holder |
| Size | 474x168x180 mm | 474x168.5x180 mm | 474x169x180 mm |
| Material | PC+ABS | PC+ABS | PC+ABS |
| Colour | Clear/White/Black | Clear/White/Black | Clear/White/Black |
| PCS/CTN | 6 | 6 | 6 |

Plastic Barware



JW-BSW



JW-BSK



JW-BMC



JW-BSS



JW-BC



JW-BC2

| Art.No. | JW-BSK | JW-BSW | JW-BMC | JW-BSS | JW-BC | JW-BC2 |
|----------|-----------------|-----------------|-----------------|-------------------------|----------------|----------------|
| Name | Cocktail Shaker | Cocktail Shaker | Cocktail Shaker | Salt&Sugar Glass Rimmer | Bar Caddy | Bar Caddy |
| Size | Φ94x60x170 mm | Φ94x60x170 mm | Φ87x61x145 mm | 200x160x70 mm | 240x150x105 mm | 194x142x136 mm |
| Capacity | 750ml | 750ml | / | / | / | / |
| Colour | Primary | Black/Red | Clear | Black | Black | Black |
| Material | S/S | S/S /Vinyl | PC | ABS | ABS | ABS |
| PCS/CTN | 24 | 24 | 24 | 24 | 24 | 24 |



JW-BMQ



JW-GSM



JW-GBM



JW-BMT

| Art.No. | JW-BMQ | JW-GSM | JW-GBM | JW-BMT |
|----------|---------------|---------------|--------------|----------------|
| Name | Service Mat | Service Mat | Bar Mat | Bar Mat |
| Size | 450x300x10 mm | 300x150x10 mm | 600x80x16 mm | 602x80x18.5 mm |
| Capacity | / | / | / | / |
| Colour | Black/Brown | Black | Black | Black/Brown |
| Material | TPE | TPE | TPE | TPE |
| PCS/CTN | 12 | 12 | 12 | 12 |

Note: Brown bar mat requires a MOQ.



JW-MC20



JW-MC40



P-038

P-039

P-040



JW-BNN

| Art.No. | JW-MC20 | JW-MC40 | P-038 | P-039 | P-040 | JW-BNN |
|----------|------------------|------------------|---------------|---------------|--------------|------------------|
| Name | 20cc Measure Cup | 40cc Measure Cup | Big Scoops | Medium Scoops | Small Scoops | Non-Slip Bar Net |
| Size | 43x88 mm | 48x106 mm | 330x150x140mm | 280x120x120mm | 250x80x55mm | 600x12000 mm |
| Capacity | 10cc/20cc | 20cc/40cc | 64oz. | 32oz. | 6oz. | / |
| Colour | Clear | Clear | Clear | Clear | Clear | Black |
| Material | PC | PC | PC | PC | PC | PE |
| PCS/CTN | 64 | 64 | 24 | 24 | 36 | 6 |

Plastic Barware



| Art.No. | P-030 | P-031 | P-032 | P-033 | P-034 | P-035 |
|----------|------------------------------------|--|----------------------------------|--------------------------------------|------------------------------------|--|
| Name | Small Bar Muddler With Netted Head | Small Bar Muddler With Triangular Head | Big Bar Muddler With Netted Head | Big Bar Muddler With Triangular Head | Small Bar Muddler With Netted Head | Small Bar Muddler With Triangular Head |
| Size | Φ27x210 mm | Φ27x210 mm | Φ39.5x240 mm | Φ39.5x240 mm | Φ27x210 mm | Φ27x210 mm |
| Colour | Black | Black | Black | Black | Black | Black |
| Material | ABS | ABS | ABS | ABS | PC | PC |
| PCS/CTN | 72 | 72 | 72 | 72 | 72 | 72 |



| Art.No. | P-036 | P-037 | JW-501 | JW-BFW | JW-BFB | JW-BFG |
|----------|----------------------------------|--------------------------------------|-------------|--------------|--------------------|----------------------|
| Name | Big Bar Muddler With Netted Head | Big Bar Muddler With Triangular Head | Wine Bucket | Flair Bottle | Flair Bottle | Flair Bottle |
| Size | Φ39.5x240 mm | Φ39.5x240 mm | Φ115x230 mm | Φ77x290 mm | Φ77x290 mm | Φ77x290 mm |
| Colour | Black | Black | Clear | White | White With Printed | Phosp horushorescent |
| Material | PC | PC | AS | ABS | ABS | ABS |
| PCS/CTN | 72 | 72 | 12 | 24 | 24 | 24 |

Note: JW-BFG requires a MOQ.



| Art.No. | JW-SC78 | JW-SC106 | JW-SC110 | JW-BO | JW-BV |
|----------|---------------------------|----------------------------|-------------------------|--------------------------|-----------------------------|
| Name | Small Sugar Packet Holder | Medium Sugar Packet Holder | BIG Sugar Packet Holder | Bottle opener With Vinyl | Bottle opener Without Vinyl |
| Size | 78x52x51 mm | 106x77x57 mm | 110x65x55 mm | 181x40mm | 181x40mm |
| Material | PC | PC | PC | S/S /Vinyl | S/S |
| Colour | Clear | Clear | Clear | Red/Blue/Black | Primary |
| PCS/CTN | 240 | 48 | 48 | 24 | 24 |

Note: Sugar packet holder requires a MOQ.

Plastic Barware

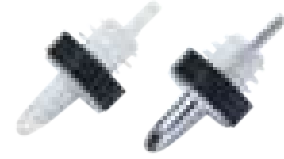

JW-FP JW-FPP

| Art.No. | JW-BW | JW-BG | JW-FP | JW-FPP |
|----------|----------------------------------|--------------------|-------------|-------------|
| Name | Whiskeygate Pourer | Whiskeygate Pourer | Free Pourer | Free Pourer |
| Colour | Clear/Black/Green/Blue/Red/White | Black/Red | Black | Black |
| Material | PC, TPE | PC, TPE | TPE, ABS | TPE, ABS |
| PCS/CTN | 360 | 360 | 360 | 360 |



| Art.No. | JW-BPP | JW-BP | JW-BS | JW-BA |
|----------|---------------------------|-----------------------------|---------------------|---------------------|
| Name | Chromed Metal Free Pourer | Chromed Plastic Free Pourer | Plastic Free Pourer | Plastic Free Pourer |
| Colour | Silver | Black | Clear | Clear |
| Material | ABS, TPE, Chromed | TPE, S/S | TPE, ABS | TPE |
| PCS/CTN | 360 | 360 | 360 | 960 |

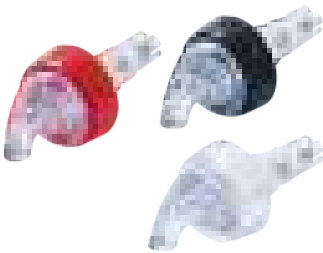

| Art.No. | JW-BB | JW-BH | JW-BR |
|----------|-----------------|-------------|---|
| Name | Measured Pourer | Measured | Economy Free Pourer |
| Colour | Black/Clear/Red | Clear/Black | Clear/White/Red/Blue/Yellow/Green/Black/Purple/Orange |
| Material | PC, AS | PC, TPE | TPE |
| PCS/CTN | 90 | 360 | 960 |

Plastic Barware

Polycarbonate Pitcher



| Art.No. | JW-601 | JW-602 | JW-603 | JW-609 | JW-610 | JW-610A | JW-610B |
|----------|-----------------------|-----------------------|-----------------------|-----------------------|-----------------------|-------------------------------|--------------------------|
| Name | Polycarbonate Pitcher | Polycarbonate Pitcher | Polycarbonate Pitcher | Polycarbonate Pitcher | Polycarbonate Pitcher | Pitcher With Infusion Chamber | Pitcher With Ice Chamber |
| Size | Φ128x200 mm | Φ115x200 mm | Φ104x170 mm | Φ138x230 mm | Φ133x240 mm | Φ133x240 mm | Φ133x240 mm |
| Capacity | 1.8L(60oz.) | 1.4L(42oz.) | 0.95L(28.5oz.) | 1.9L(63oz.) | 1.9L(63oz.) | 1.9L(63oz.) | 1.9L(63oz.) |
| Colour | Clear | Clear | Clear | Clear | Clear | Clear | Clear |
| Material | PC | PC | PC | PC | PC | PC | PC |
| PCS/CTN | 12 | 12 | 12 | 12 | 12 | 12 | 12 |

Measuring Cup



| Art.No. | JW-608C | JW-607C | JW-606C | JW-605C | JW-604C |
|----------|---------------|---------------|---------------|---------------|---------------|
| Name | Measuring Cup | Measuring Cup | Measuring Cup | Measuring Cup | Measuring Cup |
| Size | Φ70x87 mm | Φ90x124 mm | Φ115x164 mm | Φ147x215 mm | Φ165x241 mm |
| Capacity | 250ml | 500ml | 1000ml | 2000ml | 3000ml |
| Colour | Clear | Clear | Clear | Clear | Clear |
| Material | PC | PC | PC | PC | PC |
| PCS/CTN | 12 | 12 | 12 | 12 | 12 |

Measured Plastic Shaker



| Art.No. | JW-X3001 | JW-X4501 | JW-X6001 | JW-X8001 | JW-X9001 |
|----------|-------------------------|-------------------------|-------------------------|-------------------------|-------------------------|
| Name | Measured Plastic Shaker | Measured Plastic Shaker | Measured Plastic Shaker | Measured Plastic Shaker | Measured Plastic Shaker |
| Size | Φ82x168 mm | Φ90x192 mm | Φ90x219.5 mm | Φ95x251 mm | Φ90x284.5 mm |
| Capacity | 300ml | 450ml | 600ml | 800ml | 900ml |
| Colour | Clear | Clear | Clear | Clear | Clear |
| Material | PC | PC | PC | PC | PC |
| PCS/CTN | 18 | 18 | 18 | 18 | 9 |

Note: This item requires a MOQ.

Ice Bucket Series



| Art.No. | JW-I001 | JW-I002 | JW-I003 | JW-I004 | JW-I005 |
|----------|-------------------|-------------------|-------------------|-------------------|-------------------|
| Name | Ice Bucket Series | Ice Bucket Series | Ice Bucket Series | Ice Bucket Series | Ice Bucket Series |
| Size | 120x140 mm | 120x115 mm | 125x130 mm | 125x140 mm | 195x210 mm |
| Capacity | 1000ml | 800ml | 1000ml | 1000ml | 3000ml |
| Colour | Clear | Clear | Clear | Clear | Clear |
| Material | PC | PC | PC | PC | PC |
| PCS/CTN | 12 | 12 | 12 | 12 | 4 |

Note: This item requires a MOQ.

Winshelvings

Multi environments use
From -38°C to 88°C

Stationary Units

Mobile Units

High-Density Units

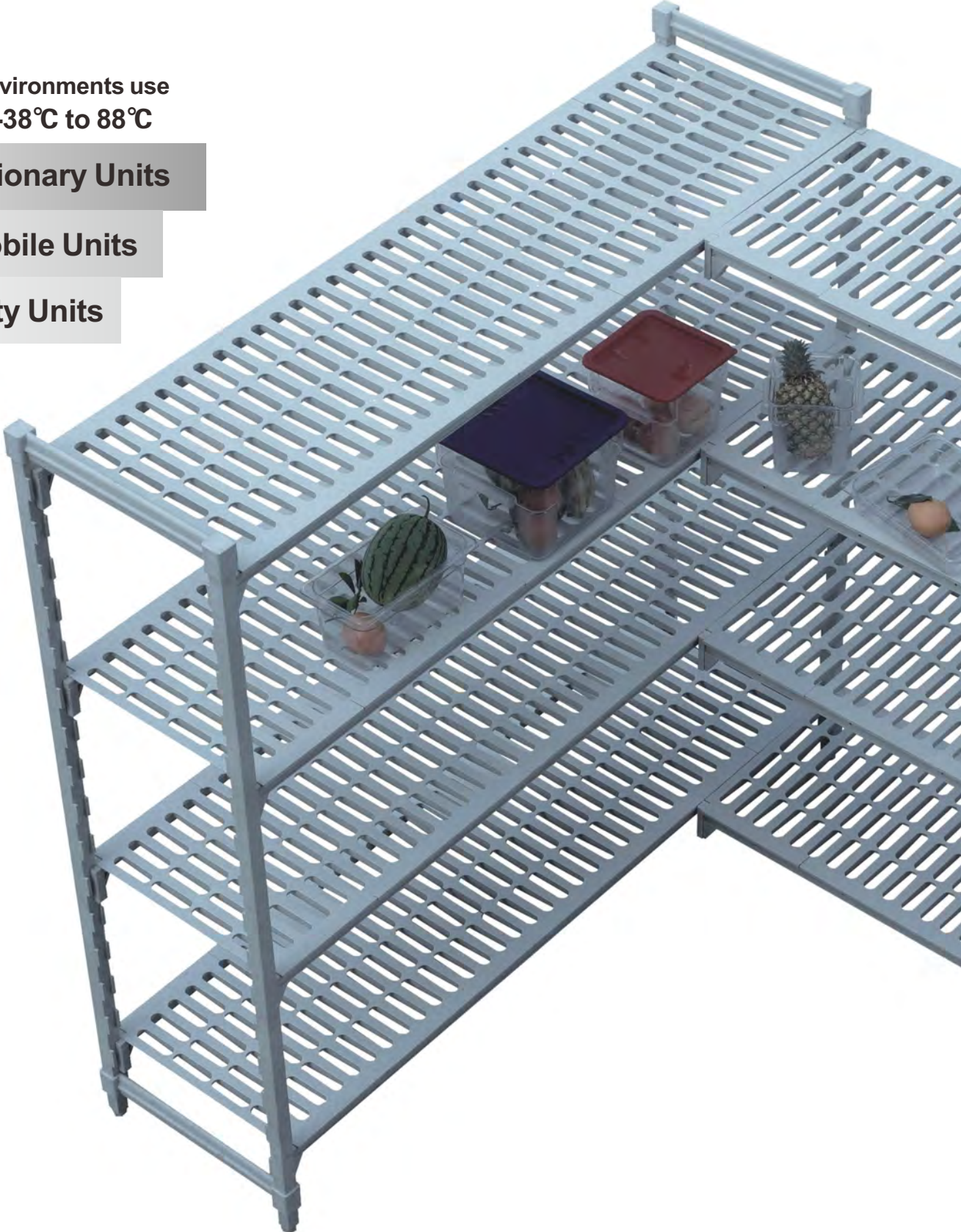

Winshelvings

Easy to adjust and install

It's easy to adjust and install.
With different sizes (3 heights, 4 widths, 6 lengths),
space utilization is highly increased.
The nets can be adjusted up or down by 100
millimeters with disassembly.
Shelves can be built to U-shape units with corner
connectors.

Absolutely firm, durable and stable

Made of a steel core and polypropylene.
Inner steel provides high intensity and durability.
Exterior PP is anti-corrosion and break-resistant
Post connectors provide exceptional stabilization.

Never rusty

Can be used anywhere, no matter moist or dry
weldless, never rusty.
Resists corrosion by brine or marine air.
Suitable for coolers and freezers, available
under -38°C.

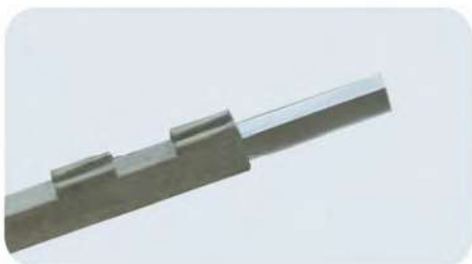

Winshelvings

Basic Unit

The components of shelf can be formed into various specifications of basic units.



Vented Basic Unit



Solid Basic Unit

Add-on Unit

When added to a basic unit, the traverses on the first and second unit share the middle post. As a result, only two additional posts, instead of four posts or any add-on clips, are needed.



Corner Unit and U shape Unit

Corner connectors can build corner units and U-shape units. Traverses snap onto corner connectors just like they snap onto the dovetails of the posts.

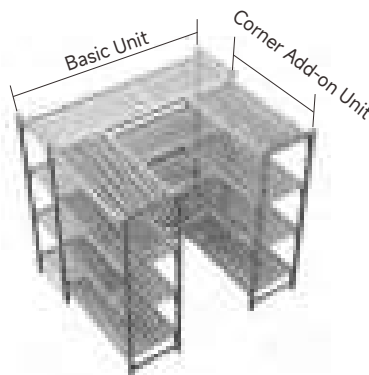
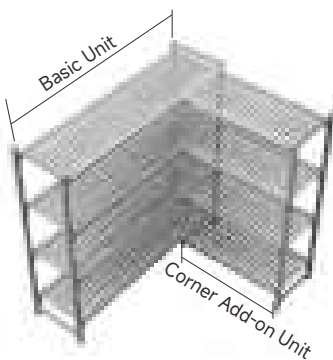

Mobile Unit

Inserting the specialized bolts into the casters to change the storage shelves into the move aluminum shelving system. Mobile units are unsuitable to be used as transporting cart.



Heavy-duty Rack

To store frozen, cold and dry items 22.5cm safely off the floor. Rust free, corrosion proof and non-blending, the maximum weight load is 350kg. Different sizes of 6 heights, 4 widths of corner connectors and dunnage stand are available. Above 1220mm size must be assembled with dunnage stands and corner connectors to make sure its loading capacity.



Solid Dunnage Rack

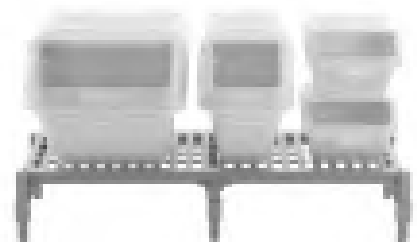

Vented Dunnage Rack

Winshelvings Size Diagram

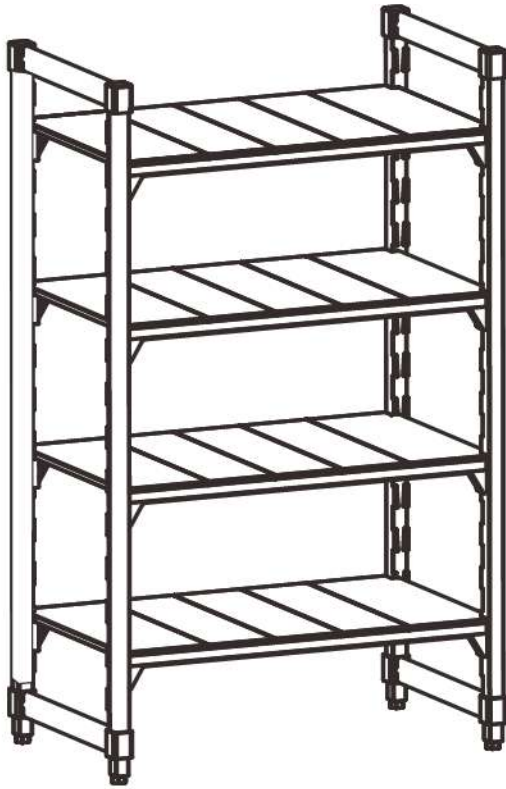

Stationary Units



Mobile Unit

Stationary Units

| | | | | |
|---------------|-------------|-------------|-------------|-------------|
| Length | 910mm(36") | 1060mm(42") | 1220mm(48") | 1370mm(54") |
| | 1525mm(60") | 1825mm(72") | | |
| Width | 355mm(14") | 455mm(18") | 530mm(21") | 610mm(24") |
| Height | 1600mm(64") | 1800mm(72") | 2000mm(80") | |

Mobile Unit

| | | | |
|---------------|------------|-------------|-------------|
| Length | 910mm(36") | 1060mm(42") | 1220mm(48") |
| Width | 455mm(18") | 530mm(21") | 610mm(24") |
| Height | 1690mm | 1890mm | 2090mm |

Weight Bearing Capacity

Weight must be evenly distributed throughout the frame.

| | | Length 910-1220 mm | Length 1370-1825mm |
|---------------|---|-----------------------|-----------------------|
| Single Unit | Weight Bearing capacity per for shelves | 1400 kg | 1000 kg |
| | Weight Bearing capacity per unit | 350 | 250 |
| Corner Unit | Weight Bearing capacity per for shelves | 600 | — |
| | Weight Bearing capacity per unit | 150 | — |
| Mobile Unit | Weight Bearing capacity per for shelves | 340 | — |
| Dunnage Stand | Single Unit | 450 | — |

Note: As the casters have load-bearing capacity, the maximum load-bearing capacity of the mobile frame is 340 kg.

Winshelvings Parts

Casters

It is suitable for all storage areas, especially for refrigerated rooms and wet areas. It consists of highly durable, non-corroded plastic and 127mm non-marking thermoplastic rubber universal wheel.

| Art.No. | PSL | PS |
|-----------|------------|---------------|
| Direction | With Brake | Without Brake |
| Size | 127mm / 5" | 127mm / 5" |

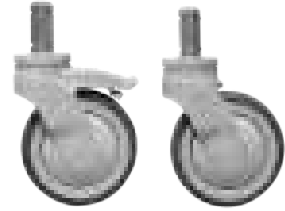

Corner Connector Set

Corner connectors can be used to build corner units or U-shaped units. A set of corner connectors is needed for each shelf. When corner connectors are used, weight bearing capacity will be decreased to 180kg per shelf. Recommended for travelers equal to or shorter than 1220mm.



Tool for assembling removing corner connector .



PCC Corner Connector

Shelf Plates

The material of shelf plates is polypropylene. The design of shelf plates is solid or vented.

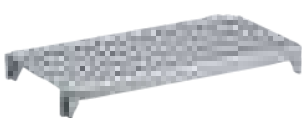

Vented Shelf Kits



Solid Shelf Kits



Post Connectors

Post connectors hold two posts together and define the width of the unit. Be made of polypropylene, provide exceptional cross stabilization.

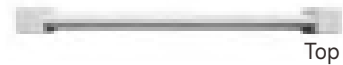

Top



Bottom

Dunnage Stand

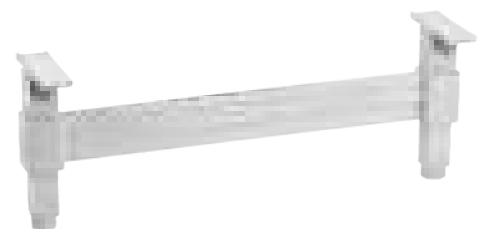

Recommended for 1370mm or longer. Recommended for weight bearing capacity to 450kg on the bottom shelf.



Winshelvings Parts

Fence system

Used to prevent the stored items from falling off shelving.
Ideal for mobile shelving units.

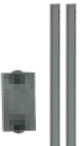
| | Fits Traverse | 910 ^{36"} mm | 1060 ^{42"} mm | 1220 ^{48"} mm | 1370 ^{54"} mm | 1525 ^{60"} mm | 1825 ^{72"} mm |
|--|---------------------|--------------------------|---------------------------|---------------------------|---------------------------|---------------------------|---------------------------|
|  | Art.No. | FSD362 | FSD422 | FSD482 | FSD542 | FSD602 | FSD722 |
| | Brackets | 2 | 3 | 4 | 4 | 4 | 5 |
| | Rods | 2 | 2 | 2 | 2 | 2 | 2 |
| | Rods Length | Φ 10x830 | Φ 10x980 | Φ 10x1140 | Φ 10x1290 | Φ 10x1445 | Φ 10x1750 |
|  | Art.No. | FSS361 | FSS421 | FSS481 | FSS541 | FSS601 | FSS721 |
| | Brackets | 2 | 3 | 3 | 4 | 4 | 5 |
| | Rods | 1 | 1 | 1 | 1 | 1 | 1 |
| | Rods Length | Φ 10x830 | Φ 10x980 | Φ 10x1140 | Φ 10x1290 | Φ 10x1445 | Φ 10x1750 |
|  | Fits Post Connector | 355 ^{14"} mm | 455 ^{18"} mm | 530 ^{21"} mm | 610 ^{24"} mm | | |
| | Art.No. | FSE14 | FSE18 | FSE21 | FSE24 | | |
| | Brackets | 2 | 2 | 2 | 2 | | |
| | Rods Length | Φ 10x253 | Φ 10x353 | Φ 10x428 | Φ 10x508 | | |

Stationary Post kits And Accessories

| | Height | Width | 355 ^{14"} mm | 455 ^{18"} mm | 530 ^{21"} mm | 610 ^{24"} mm |
|---|---------------------------|-------------|--------------------------|--------------------------|--------------------------|--------------------------|
|  | 1600 ^{64"} mm | Art.No. | PSPK1464 | PSPK1864 | PSPK2164 | PSPK2464 |
| | | Weight/Cube | 6.06/0.0150 | 6.28/0.0150 | 6.48/0.0150 | 6.62/0.0150 |
| | 1800 ^{72"} mm | Art.No. | PSPK1472 | PSPK1872 | PSPK2172 | PSPK2472 |
| | | Weight/Cube | 6.72/0.0160 | 6.94/0.0160 | 7.14/0.0160 | 7.28/0.0160 |
| | 2000 ^{80"} mm | Art.No. | PSPK1480 | PSPK1880 | PSPK2180 | PSPK2480 |
| | | Weight/Cube | 7.76/0.0182 | 7.98/0.0182 | 8.18/0.0182 | 8.32/0.0182 |

Case Pack: 1 Colour: Spot Dust

Winshelvings PVC Cover

| Height | Width | Length | 910 ^{36"} mm | 1060 ^{42"} mm | 1220 ^{48"} mm | 1370 ^{54"} mm | 1525 ^{60"} mm | |
|---|---------------------------|--------------------------|--------------------------|---------------------------|---------------------------|---------------------------|---------------------------|----------------|
|  | 530 ^{21"} mm | Art.No. | JW-PSU362172VC | JW-PSU422172VC | JW-PSU482172VC | JW-PSU542172VC | JW-PSU602172VC | |
| | | Size | 528x912x1800 | 528x1065x1800 | 528x1223x1800 | 528x1374x1800 | 528x1530x1800 | |
| | 1800 ^{72"} mm | 610 ^{24"} mm | Art.No. | JW-PSU362472VC | JW-PSU422472VC | JW-PSU482472VC | JW-PSU542472VC | JW-PSU602472VC |
| | | | Size | 606x912x1800 | 606x1065x1800 | 606x1223x1800 | 606x1374x1800 | 606x1530x1800 |

Winshelvings

Heaver Dunnage Rack



Height: 255mm 12"

Dunnage stand

| Width | Length | Shelf Plates | 910 ^{36"} mm | 1220 ^{48"} mm | 1525 ^{60"} mm |
|--------------------------|----------|---------------------|--------------------------|---------------------------|---------------------------|
| 530 ^{21"} mm | Art. No. | Vented Dunnage Rack | PSH3621 | PSH4821 | PSH6021 |
| | Weight | | 9.15 | 10.79 | 12.43 |
| 530 ^{21"} mm | Art. No. | Solid Dunnage Rack | PSD3621 | PSD4821 | PSD6021 |
| | Weight | | 9.25 | 10.81 | 12.53 |

Vented Shelf Kits

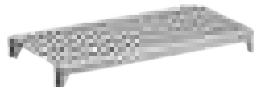

| Width | Length | 910 ^{36"} mm | 1060 ^{42"} mm | 1220 ^{48"} mm | 1370 ^{54"} mm | 1525 ^{60"} mm | 1825 ^{72"} mm |
|--------------------------|----------|--------------------------|---------------------------|---------------------------|---------------------------|---------------------------|---------------------------|
| 355 ^{14"} mm | Art. No. | PS3614VK | PS4214VK | PS4814VK | PS5414VK | PS6014VK | PS7214VK |
| | Weight | 4.00 | 4.61 | 5.29 | 6.03 | 6.72 | 11.17 |
| 455 ^{18"} mm | Art. No. | PS3618VK | PS4218VK | PS4818VK | PS5418VK | PS6018VK | PS7218VK |
| | Weight | 4.64 | 5.35 | 6.17 | 7.01 | 7.79 | 12.48 |
| 530 ^{21"} mm | Art. No. | PS3621VK | PS4221VK | PS4821VK | PS5421VK | PS6021VK | PS7221VK |
| | Weight | 5.01 | 5.73 | 6.64 | 7.49 | 8.30 | 13.09 |
| 610 ^{24"} mm | Art. No. | PS3624VK | PS4224VK | PS4824VK | PS5424VK | PS6024VK | PS7224VK |
| | Weight | 5.15 | 6.01 | 6.83 | 7.89 | 8.75 | 13.59 |

Solid Shelf Kits



| Width | Length | 910 ^{36"} mm | 1060 ^{42"} mm | 1220 ^{48"} mm | 1370 ^{54"} mm | 1525 ^{60"} mm | 1825 ^{72"} mm |
|--------------------------|----------|--------------------------|---------------------------|---------------------------|---------------------------|---------------------------|---------------------------|
| 455 ^{18"} mm | Art. No. | PS3618SK | PS4218SK | PS4818SK | PS5418SK | PS6018SK | PS7218SK |
| | Weight | 4.77 | 5.52 | 6.32 | 7.21 | 8.02 | 12.41 |
| 530 ^{21"} mm | Art. No. | PS3621SK | PS4221SK | PS4821SK | PS5421SK | PS6021SK | PS7221SK |
| | Weight | 5.02 | 5.75 | 6.66 | 7.52 | 7.69 | 13.12 |
| 610 ^{24"} mm | Art. No. | PS3624SK | PS4224SK | PS4824SK | PS5424SK | PS6024SK | PS7224SK |
| | Weight | 5.35 | 6.18 | 7.13 | 8.08 | 9.00 | 13.93 |

Winshelvings

1600^{64"}mm Vented Starter Units

| Width | Length | 910 ^{36"} mm | 1060 ^{42"} mm | 1220 ^{48"} mm | 1370 ^{54"} mm | 1525 ^{60"} mm | 1825 ^{72"} mm |
|-----------------------|-------------|-----------------------|------------------------|------------------------|------------------------|------------------------|------------------------|
| 355 ^{14"} mm | Art.No. | PSU361464 | PSU421464 | PSU481464 | PSU541464 | PSU601464 | PSU721464 |
| | Weight/Cube | 28.40/0.076 | 31.15/0.092 | 33.91/0.096 | 37.31/0.112 | 40.76/0.114 | 45.09/0.143 |
| 455 ^{18"} mm | Art.No. | PSU361864 | PSU421864 | PSU481864 | PSU541864 | PSU601864 | PSU721864 |
| | Weight/Cube | 31.30/0.084 | 34.47/0.100 | 37.76/0.106 | 41.58/0.122 | 45.34/0.127 | 21.02/0.154 |
| 530 ^{21"} mm | Art.No. | PSU362164 | PSU422164 | PSU482164 | PSU542164 | PSU602164 | PSU722164 |
| | Weight/Cube | 33.14/0.098 | 36.41/0.114 | 39.86/0.128 | 43.78/0.134 | 47.46/0.145 | 53.53/0.172 |
| 610 ^{24"} mm | Art.No. | PSU362464 | PSU422464 | PSU482464 | PSU542464 | PSU602464 | PSU722464 |
| | Weight/Cube | 33.97/0.103 | 37.86/0.113 | 40.97/0.137 | 45.49/0.148 | 49.89/0.156 | 55.65/0.189 |

1800^{72"}mm Vented Starter Units

Línea más comercial en el mercado

| Width | Length | 910 ^{36"} mm | 1060 ^{42"} mm | 1220 ^{48"} mm | 1370 ^{54"} mm | 1525 ^{60"} mm | 1825 ^{72"} mm |
|-----------------------|-------------|-----------------------|------------------------|------------------------|------------------------|------------------------|------------------------|
| 355 ^{14"} mm | Art.No. | PSU361472 | PSU421472 | PSU481472 | PSU541472 | PSU601472 | PSU721472 |
| | Weight/Cube | 30.15/0.078 | 32.50/0.094 | 35.66/0.098 | 39.06/0.114 | 42.51/0.116 | 46.84/0.145 |
| 455 ^{18"} mm | Art.No. | PSU361872 | PSU421872 | PSU481872 | PSU541872 | PSU601872 | PSU721872 |
| | Weight/Cube | 33.05/0.086 | 36.22/0.102 | 39.51/0.108 | 43.33/0.124 | 47.09/0.129 | 52.77/0.156 |
| 530 ^{21"} mm | Art.No. | PSU362172 | PSU422172 | PSU482172 | PSU542172 | PSU602172 | PSU722172 |
| | Weight/Cube | 34.89/0.100 | 38.16/0.116 | 41.61/0.130 | 45.53/0.138 | 49.21/0.147 | 55.28/0.174 |
| 610 ^{24"} mm | Art.No. | PSU362472 | PSU422472 | PSU482472 | PSU542472 | PSU602472 | PSU722472 |
| | Weight/Cube | 35.72/0.107 | 39.61/0.117 | 42.72/0.140 | 47.24/0.160 | 51.64/0.161 | 57.40/0.202 |

2000^{80"}mm Vented Starter Units

| Width | Length | 910 ^{36"} mm | 1060 ^{42"} mm | 1220 ^{48"} mm | 1370 ^{54"} mm | 1525 ^{60"} mm | 1825 ^{72"} mm |
|-----------------------|-------------|-----------------------|------------------------|------------------------|------------------------|------------------------|------------------------|
| 355 ^{14"} mm | Art.No. | PSU361480 | PSU421480 | PSU481480 | PSU541480 | PSU601480 | PSU721480 |
| | Weight/Cube | 31.12/0.081 | 33.47/0.097 | 36.63/0.101 | 40.48/0.119 | 43.48/0.119 | 47.81/0.148 |
| 455 ^{18"} mm | Art.No. | PSU361880 | PSU421880 | PSU481880 | PSU541880 | PSU601880 | PSU721880 |
| | Weight/Cube | 34.42/0.089 | 37.19/0.105 | 40.48/0.111 | 44.30/0.127 | 48.06/0.132 | 53.74/0.159 |
| 530 ^{21"} mm | Art.No. | PSU362180 | PSU422180 | PSU482180 | PSU542180 | PSU602180 | PSU722180 |
| | Weight/Cube | 35.86/0.103 | 39.13/0.119 | 42.58/0.133 | 46.50/0.141 | 50.18/0.150 | 56.25/0.177 |
| 610 ^{24"} mm | Art.No. | PSU362480 | PSU422480 | PSU482480 | PSU542480 | PSU602480 | PSU722480 |
| | Weight/Cube | 36.69/0.110 | 40.58/0.120 | 43.69/0.143 | 48.21/0.163 | 52.61/0.164 | 58.37/0.205 |

Winshelvings

1600^{64"} mm Vented Starter Add-on Units

| Width | Length | 910 ^{36"} mm | 1060 ^{42"} mm | 1220 ^{48"} mm | 1370 ^{54"} mm | 1525 ^{60"} mm | 1825 ^{72"} mm |
|--------------------------|-------------|--------------------------|---------------------------|---------------------------|---------------------------|---------------------------|---------------------------|
| 355 ^{14"} mm | Art.No. | PSA361464 | PSA421464 | PSA481464 | PSA541464 | PSA601464 | PSA721464 |
| | Weight/Cube | 22.28/0.076 | 25.03/0.092 | 27.79/0.096 | 31.19/0.112 | 34.64/0.114 | 38.97/0.143 |
| 455 ^{18"} mm | Art.No. | PSA361864 | PSA421864 | PSA481864 | PSA541864 | PSA601864 | PSA721864 |
| | Weight/Cube | 24.97/0.084 | 28.14/0.100 | 31.43/0.106 | 35.25/0.122 | 39.01/0.127 | 44.69/0.154 |
| 530 ^{21"} mm | Art.No. | PSA362164 | PSA422164 | PSA482164 | PSA542164 | PSA602164 | PSA722164 |
| | Weight/Cube | 26.66/0.098 | 29.93/0.114 | 33.38/0.128 | 37.30/0.134 | 40.98/0.145 | 47.05/0.172 |
| 610 ^{24"} mm | Art.No. | PSA362464 | PSA422464 | PSA482464 | PSA542464 | PSA602464 | PSA722464 |
| | Weight/Cube | 27.28/0.103 | 31.18/0.113 | 34.28/0.137 | 38.80/0.148 | 43.20/0.156 | 48.96/0.189 |

1800^{72"} mm Vented Starter Add-on Units

| Width | Length | 910 ^{36"} mm | 1060 ^{42"} mm | 1220 ^{48"} mm | 1370 ^{54"} mm | 1525 ^{60"} mm | 1825 ^{72"} mm |
|--------------------------|-------------|--------------------------|---------------------------|---------------------------|---------------------------|---------------------------|---------------------------|
| 355 ^{14"} mm | Art.No. | PSA361472 | PSA421472 | PSA481472 | PSA541472 | PSA601472 | PSA721472 |
| | Weight/Cube | 23.16/0.078 | 25.51/0.094 | 28.67/0.098 | 32.09/0.114 | 35.52/0.116 | 39.85/0.145 |
| 455 ^{18"} mm | Art.No. | PSA361872 | PSA421872 | PSA481872 | PSA541872 | PSA601872 | PSA721872 |
| | Weight/Cube | 25.85/0.086 | 29.02/0.102 | 32.31/0.108 | 36.13/0.124 | 39.89/0.129 | 45.57/0.156 |
| 530 ^{21"} mm | Art.No. | PSA362172 | PSA422172 | PSA482172 | PSA542172 | PSA602172 | PSA722172 |
| | Weight/Cube | 27.54/0.100 | 30.81/0.116 | 34.26/0.130 | 38.18/0.138 | 41.86/0.147 | 47.93/0.174 |
| 610 ^{24"} mm | Art.No. | PSA362472 | PSA422472 | PSA482472 | PSA542472 | PSA602472 | PSA722472 |
| | Weight/Cube | 28.15/0.107 | 32.04/0.117 | 35.15/0.140 | 39.68/0.160 | 44.07/0.161 | 49.83/0.202 |

2000^{80"} mm Vented Starter Add-on Units

| Width | Length | 910 ^{36"} mm | 1060 ^{42"} mm | 1220 ^{48"} mm | 1370 ^{54"} mm | 1525 ^{60"} mm | 1825 ^{72"} mm |
|--------------------------|-------------|--------------------------|---------------------------|---------------------------|---------------------------|---------------------------|---------------------------|
| 355 ^{14"} mm | Art.No. | PSA361480 | PSA421480 | PSA481480 | PSA541480 | PSA601480 | PSA721480 |
| | Weight/Cube | 23.64/0.081 | 25.99/0.097 | 29.15/0.101 | 32.55/0.119 | 36.00/0.119 | 40.33/0.148 |
| 455 ^{18"} mm | Art.No. | PSA361880 | PSA421880 | PSA481880 | PSA541880 | PSA601880 | PSA721880 |
| | Weight/Cube | 26.73/0.089 | 29.50/0.105 | 32.79/0.111 | 36.60/0.127 | 40.37/0.132 | 46.05/0.159 |
| 530 ^{21"} mm | Art.No. | PSA362180 | PSA422180 | PSA482180 | PSA542180 | PSA602180 | PSA722180 |
| | Weight/Cube | 28.02/0.103 | 31.29/0.119 | 34.74/0.133 | 38.66/0.141 | 42.34/0.150 | 48.41/0.177 |
| 610 ^{24"} mm | Art.No. | PSA362480 | PSA422480 | PSA482480 | PSA542480 | PSA602480 | PSA722480 |
| | Weight/Cube | 28.68/0.110 | 32.57/0.120 | 35.68/0.143 | 40.20/0.163 | 44.60/0.164 | 50.36/0.205 |

Winshelvings

1600^{64"} mm Solid Starter Units

| Width | Length | 910 ^{36"} mm | 1060 ^{42"} mm | 1220 ^{48"} mm | 1370 ^{54"} mm | 1525 ^{60"} mm | 1825 ^{72"} mm |
|--------------------------|-------------|--------------------------|---------------------------|---------------------------|---------------------------|---------------------------|---------------------------|
| 455 ^{18"} mm | Art.No. | PSS361864 | PSS421864 | PSS481864 | PSS541864 | PSS601864 | PSS721864 |
| | Weight/Cube | 31.67/0.084 | 34.95/0.100 | 38.22/0.106 | 42.15/0.122 | 45.91/0.127 | 51.50/0.154 |
| 530 ^{21"} mm | Art.No. | PSS362164 | PSS422164 | PSS482164 | PSS542164 | PSS602164 | PSS722164 |
| | Weight/Cube | 33.21/0.098 | 36.49/0.114 | 40.09/0.128 | 43.97/0.134 | 47.89/0.145 | 53.53/0.172 |
| 610 ^{24"} mm | Art.No. | PSS362464 | PSS422464 | PSS482464 | PSS542464 | PSS602464 | PSS722464 |
| | Weight/Cube | 35.85/0.103 | 39.45/0.113 | 43.28/0.137 | 47.41/0.148 | 51.60/0.156 | 57.85/0.189 |

1800^{72"} mm Solid Starter Units

| Width | Length | 910 ^{36"} mm | 1060 ^{42"} mm | 1220 ^{48"} mm | 1370 ^{54"} mm | 1525 ^{60"} mm | 1825 ^{72"} mm |
|--------------------------|-------------|--------------------------|---------------------------|---------------------------|---------------------------|---------------------------|---------------------------|
| 455 ^{18"} mm | Art.No. | PSS361872 | PSS421872 | PSS481872 | PSS541872 | PSS601872 | PSS721872 |
| | Weight/Cube | 33.42/0.086 | 36.70/0.102 | 39.97/0.108 | 43.90/0.124 | 48.08/0.129 | 53.25/0.156 |
| 530 ^{21"} mm | Art.No. | PSS362172 | PSS422172 | PSS482172 | PSS542172 | PSS602172 | PSS722172 |
| | Weight/Cube | 34.96/0.100 | 38.24/0.116 | 41.84/0.130 | 45.72/0.138 | 49.63/0.147 | 55.28/0.174 |
| 610 ^{24"} mm | Art.No. | PSS362472 | PSS422472 | PSS482472 | PSS542472 | PSS602472 | PSS722472 |
| | Weight/Cube | 37.60/0.107 | 41.10/0.117 | 54.03/0.140 | 49.16/0.160 | 53.35/0.161 | 59.60/0.202 |

2000^{80"} mm Solid Starter Units

| Width | Length | 910 ^{36"} mm | 1060 ^{42"} mm | 1220 ^{48"} mm | 1370 ^{54"} mm | 1525 ^{60"} mm | 1825 ^{72"} mm |
|--------------------------|-------------|--------------------------|---------------------------|---------------------------|---------------------------|---------------------------|---------------------------|
| 455 ^{18"} mm | Art.No. | PSS361880 | PSS421880 | PSS481880 | PSS541880 | PSS601880 | PSS721880 |
| | Weight/Cube | 34.15/0.089 | 37.67/0.105 | 40.94/0.111 | 44.87/0.127 | 49.05/0.132 | 54.32/0.159 |
| 530 ^{21"} mm | Art.No. | PSS362180 | PSS422180 | PSS482180 | PSS542180 | PSS602180 | PSS722180 |
| | Weight/Cube | 35.97/0.103 | 39.21/0.119 | 42.81/0.133 | 46.69/0.141 | 50.61/0.150 | 56.25/0.177 |
| 610 ^{24"} mm | Art.No. | PSS362480 | PSS422480 | PSS482480 | PSS542480 | PSS602480 | PSS722480 |
| | Weight/Cube | 38.57/0.110 | 42.07/0.120 | 46.00/0.143 | 50.13/0.163 | 54.32/0.164 | 60.57/0.205 |

Winshelvings

1600^{64"}mm Solid Starter Add-on Units



| Width | Length | 910 ^{36"} mm | 1060 ^{42"} mm | 1220 ^{48"} mm | 1370 ^{54"} mm | 1525 ^{60"} mm | 1825 ^{72"} mm |
|-----------------------|-------------|-----------------------|------------------------|------------------------|------------------------|------------------------|------------------------|
| 455 ^{18"} mm | Art.No. | PSD361864 | PSD421864 | PSD481864 | PSD541864 | PSD601864 | PSD721864 |
| | Weight/Cube | 25.34/0.084 | 28.63/0.100 | 31.89/0.106 | 35.82/0.122 | 40.00/0.127 | 45.17/0.154 |
| 530 ^{21"} mm | Art.No. | PSD362164 | PSD422164 | PSD482164 | PSD542164 | PSD602164 | PSD722164 |
| | Weight/Cube | 26.73/0.098 | 30.01/0.114 | 33.61/0.128 | 37.49/0.134 | 41.47/0.145 | 47.05/0.172 |
| 610 ^{24"} mm | Art.No. | PSD362464 | PSD422464 | PSD482464 | PSD542464 | PSD602464 | PSD722464 |
| | Weight/Cube | 29.16/0.103 | 32.66/0.113 | 36.59/0.137 | 40.72/0.148 | 44.91/0.156 | 51.16/0.189 |

1800^{72"}mm Solid Starter Add-on Units



| Width | Length | 910 ^{36"} mm | 1060 ^{42"} mm | 1220 ^{48"} mm | 1370 ^{54"} mm | 1525 ^{60"} mm | 1825 ^{72"} mm |
|-----------------------|-------------|-----------------------|------------------------|------------------------|------------------------|------------------------|------------------------|
| 455 ^{18"} mm | Art.No. | PSD361872 | PSD421872 | PSD481872 | PSD541872 | PSD601872 | PSD721872 |
| | Weight/Cube | 6.22/0.086 | 29.50/0.102 | 32.77/0.108 | 36.70/0.124 | 40.88/0.129 | 46.05/0.156 |
| 530 ^{21"} mm | Art.No. | PSD362172 | PSD422172 | PSD482172 | PSD542172 | PSD602172 | PSD722172 |
| | Weight/Cube | 28.01/0.100 | 30.89/0.116 | 34.49/0.130 | 38.77/0.138 | 42.29/0.147 | 47.93/0.174 |
| 610 ^{24"} mm | Art.No. | PSD362472 | PSD422472 | PSD482472 | PSD542472 | PSD602472 | PSD722472 |
| | Weight/Cube | 30.30/0.107 | 33.53/0.117 | 37.46/0.140 | 41.59/0.160 | 45.78/0.161 | 52.03/0.202 |

2000^{80"}mm Solid Starter Add-on Units



| Width | Length | 910 ^{36"} mm | 1060 ^{42"} mm | 1220 ^{48"} mm | 1370 ^{54"} mm | 1525 ^{60"} mm | 1825 ^{72"} mm |
|-----------------------|-------------|-----------------------|------------------------|------------------------|------------------------|------------------------|------------------------|
| 455 ^{18"} mm | Art.No. | PSD361880 | PSD421880 | PSD481880 | PSD541880 | PSD601880 | PSD721880 |
| | Weight/Cube | 27.10/0.089 | 29.98/0.105 | 33.25/0.111 | 37.17/0.127 | 41.36/0.132 | 46.53/0.159 |
| 530 ^{21"} mm | Art.No. | PSD362180 | PSD422180 | PSD482180 | PSD542180 | PSD602180 | PSD722180 |
| | Weight/Cube | 28.09/0.103 | 31.37/0.119 | 34.97/0.133 | 38.85/0.141 | 42.77/0.150 | 48.41/0.177 |
| 610 ^{24"} mm | Art.No. | PSD362480 | PSD422480 | PSD482480 | PSD542480 | PSD602480 | PSD722480 |
| | Weight/Cube | 30.56/0.110 | 34.06/0.120 | 37.99/0.143 | 42.12/0.163 | 46.31/0.164 | 52.56/0.205 |

Products Assembly

⊘ DO NOT USE A METAL HAMMER FOR ASSEMBLY

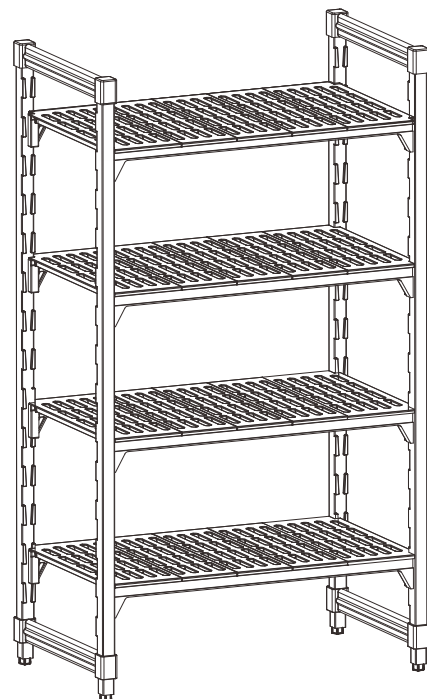
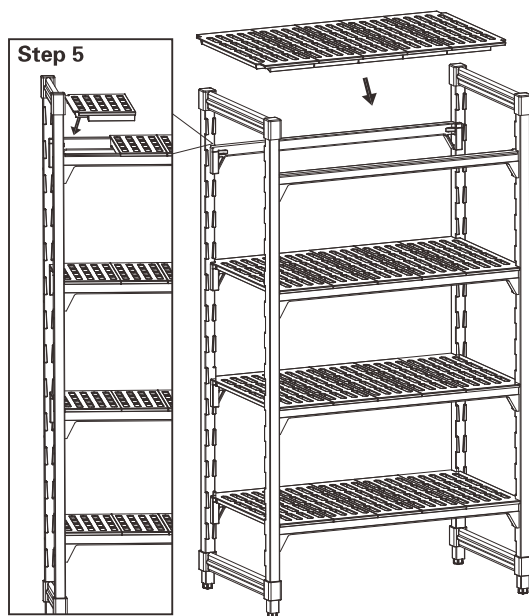
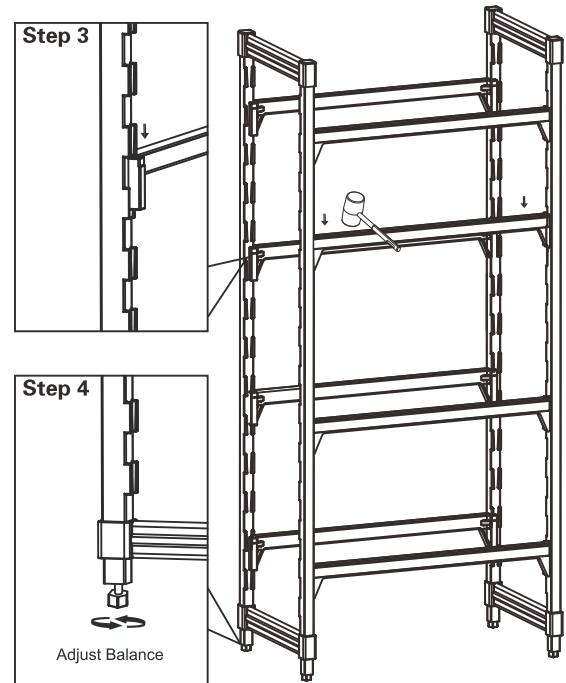
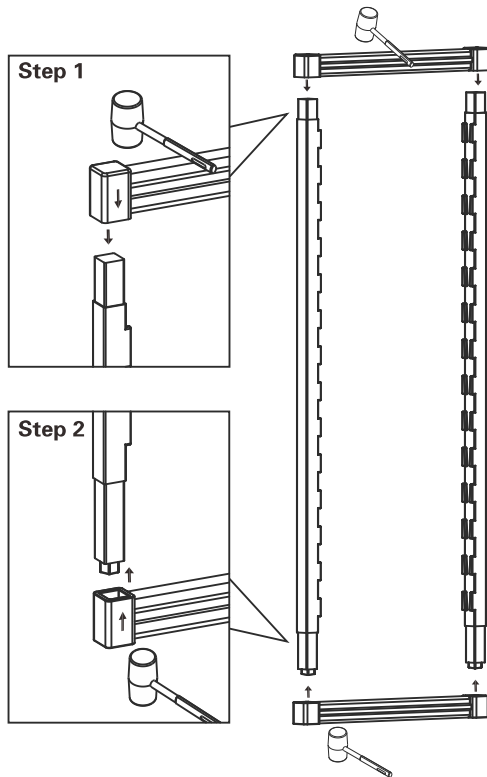

High Density Mobile Shelving Storage System

- Maximum storage capacity can be achieved by forming a storage channel in all available space.
- The mobile shelving storage system is composed of the basic units on the raised track, with high density movable shelves in the middle.
- Tracks are easy to be installed without drilling or bonding.

40%
Increase Storage
Capacity

A: Stationary Units
B: Mobile Units
C: Track
D: Active Aisle

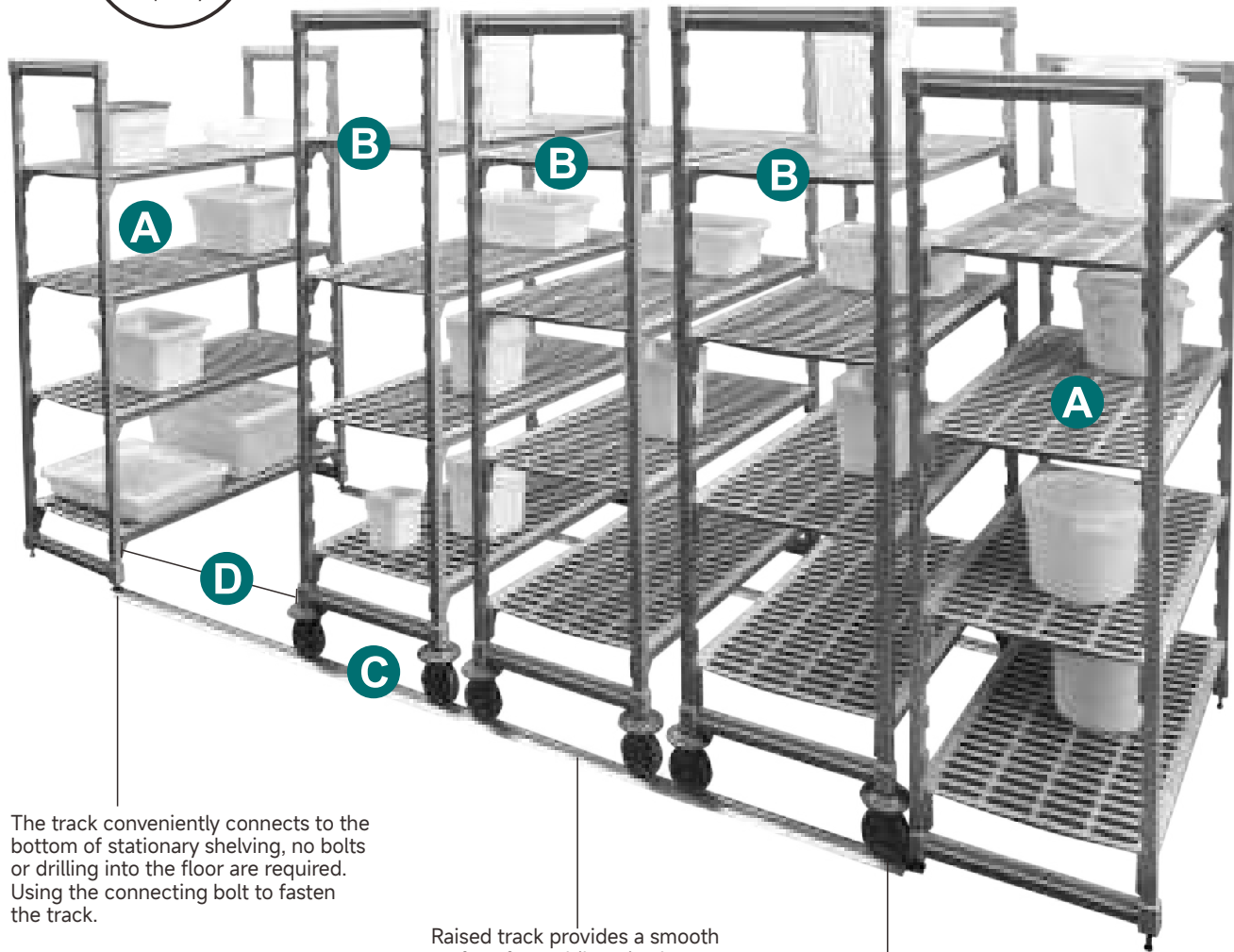

The track conveniently connects to the bottom of stationary shelving, no bolts or drilling into the floor are required. Using the connecting bolt to fasten the track.

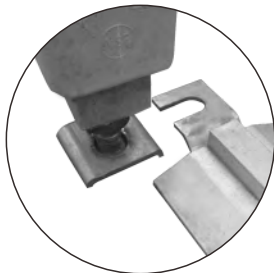

Raised track provides a smooth surface for mobile units. It ensures dirt will not get trapped, and it is easy to clean. Shelves unit with heavy weight lands can roll smoothly on the track.

Grooved casters roll easily on raised track, which can be used on any surface. The caster with a bumper can provide protection.

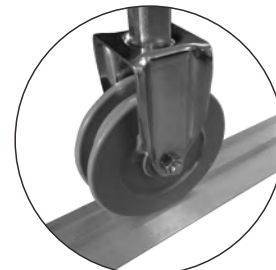

High Density Mobile Shelving Storage System

Caster

High Density Mobile Unit includes 4 High Density Casters with 4 High Density Donut Bumpers.
Weight bearing capacity of High Density Mobile Unit is 340kg.
All necessary hardware is included in the track kit.

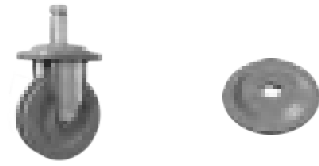

| Art.No. | JW-HDC5 | JW-HDDB5 |
|---------|------------------------|------------------------|
| Name | 5" High Density Caster | 5" High Density Bumper |
| Size | 127mm / 5" | 127mm / 5" |

Track

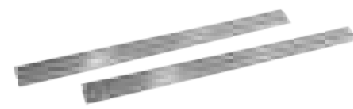
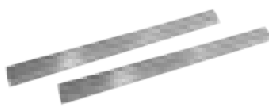

| Art.No. | JW-GD3050 | JW-GD3660 | JW-GD4420 |
|---------|-----------------------------------|-----------------------------------|-----------------------------------|
| Name | 3050mm track kit for 3 move units | 3660mm track kit for 4 move units | 4420mm track kit for 4 move units |
| Size | 3050mm | 3660mm | 4420mm |

High Density Mobile Vented Shelf ^{72"} 1880mm



| Width | Length | 910 ^{36"} mm | 1060 ^{42"} mm | 1220 ^{48"} mm | 1370 ^{54"} mm | 1525 ^{60"} mm |
|-----------------------|-------------|-----------------------|------------------------|------------------------|------------------------|------------------------|
| 530 ^{21"} mm | Art.No. | PSU362172M | PSU422172M | PSU482172M | PSU542172M | PSU602172M |
| | Weight/Cube | 34.89/0.100 | 38.16/0.116 | 41.61/0.130 | 45.53/0.138 | 49.21/0.147 |
| 610 ^{24"} mm | Art.No. | PSU362472M | PSU422472M | PSU482472M | PSU542472M | PSU602472M |
| | Weight/Cube | 35.72/0.107 | 39.61/0.117 | 42.72/0.140 | 47.24/0.160 | 51.64/0.161 |

High Density Mobile Solid Shelf ^{72"} 1880mm



| Width | Length | 910 ^{36"} mm | 1060 ^{42"} mm | 1220 ^{48"} mm | 1370 ^{54"} mm | 1525 ^{60"} mm |
|-----------------------|-------------|-----------------------|------------------------|------------------------|------------------------|------------------------|
| 530 ^{21"} mm | Art.No. | PSS362172M | PSS422172M | PSS482172M | PSS542172M | PSS602172M |
| | Weight/Cube | 34.96/0.100 | 38.24/0.116 | 41.84/0.130 | 45.72/0.138 | 49.63/0.147 |
| 610 ^{24"} mm | Art.No. | PSS362472M | PSS422472M | PSS482472M | PSS542472M | PSS602472M |
| | Weight/Cube | 37.60/0.107 | 41.10/0.117 | 54.03/0.140 | 49.16/0.160 | 53.35/0.161 |

Composite Shelving

JIWINS Composite Shelving Can be used in multi environment from -38°C to 88°C

Made of innovative high-strength composite materials so each layer can bear up to 200kg.

It is comfortable to use because of its smooth, easy-to-clean surface and its post notch embedded.

The shelf plate is added with the antibacterial agent of **Microban** brand in America, which can effectively inhibit the breeding of bacteria and ensure the safety and hygiene of stored products.

Buckle design makes installation and adjustment easier, and with good rust resistance. Products can withstand the influence by water, chemicals and other liquids. It can be used in the place under low temperature of minus 38 degrees and wet kitchen.



Mould-proof



Fungus-proof



Rust-proof



Environment
-Friendly



This series of product liability insurance by
Pacific property insurance co., LTD. Cover



Size Diagram



Stationary Units



Mobile Unit

Stationary Units

| | | | | |
|--------|-------------|-------------|-------------|-------------|
| Length | 760mm(30") | 910mm(36") | 1060mm(42") | 1220mm(48") |
| | 1370mm(54") | 1525mm(60") | 1825mm(72") | |
| Width | 455mm(18") | 530mm(21") | 610mm(24") | |
| Height | 1600mm(64") | 1800mm(72") | 2000mm(80") | |

Mobile Unit

| | | | | |
|--------|-------------|-------------|-------------|-------------|
| Length | 760mm(30") | 910mm(36") | 1060mm(42") | 1220mm(48") |
| | 1370mm(54") | 1525mm(60") | 1825mm(72") | |
| Width | 455mm(18") | 530mm(21") | 610mm(24") | |
| Height | 1775mm | 1975mm | 2175mm | |

Weight Bearing Capacity Chart

*Weight must be evenly distributed through the shelf plates.

| | | Length 760-1220 mm | Length 1370-1825mm |
|-------------|--|-----------------------|-----------------------|
| Single Unit | The holding-up capacity of a completed set of four shelf plates. | 1000 kg | 800 kg |
| | The holding-up capacity of each shelf plates. | 250 | 200 |
| Corner Unit | The holding-up capacity of a completed set of four shelf plates. | 800 | — |
| | The holding-up capacity of each shelf plates. | 200 | — |

Noted: As the casters having load-bearing capacity, the maximum load-bearing capacity of the whole set of mobile unit is 300 KG

Multiple Combinations can meet various application scenarios

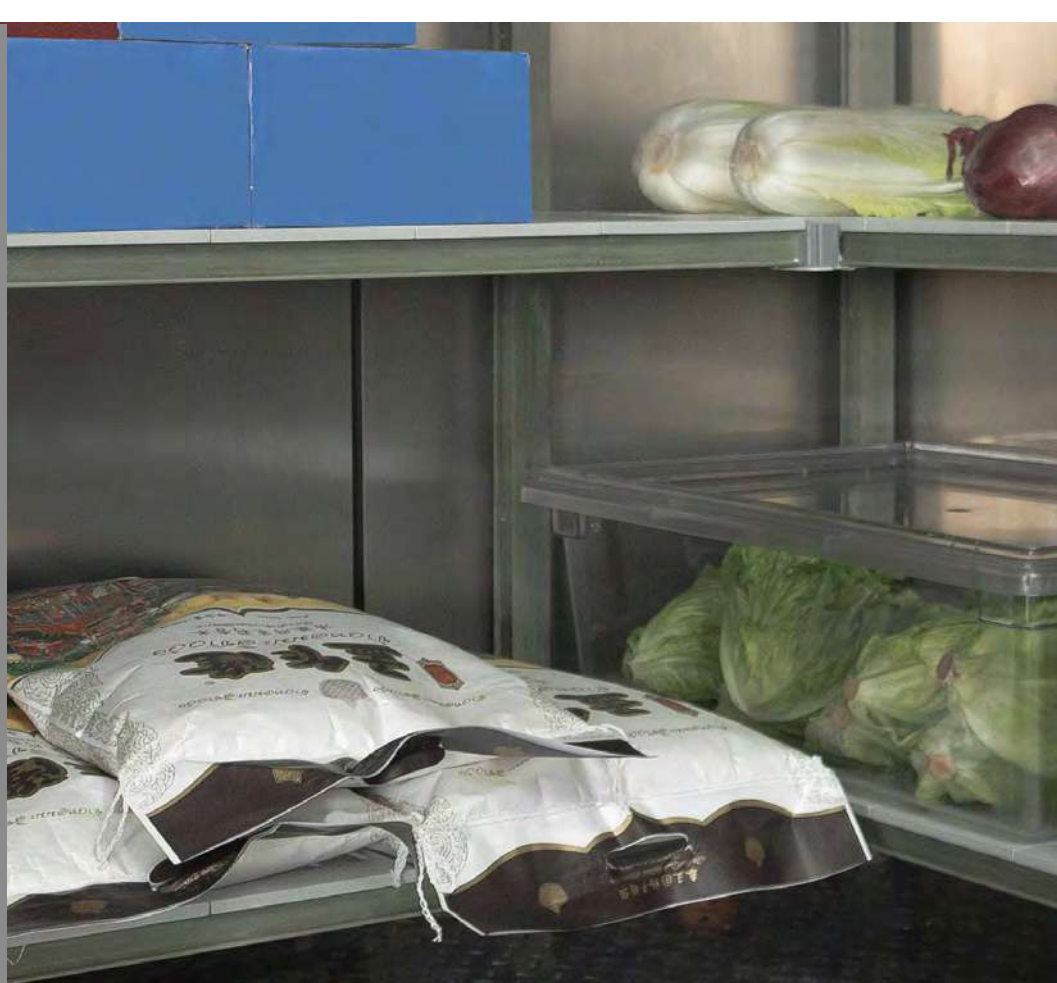

Bacis Unit

Components of composite shelving can be combined to form a variety of specifications of the basic unit.

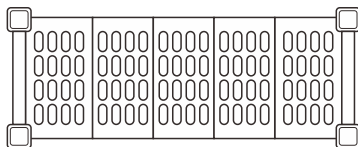

Bacis Unit

Add-on Unit

Column for common use when add-on unit is added to basic unit.

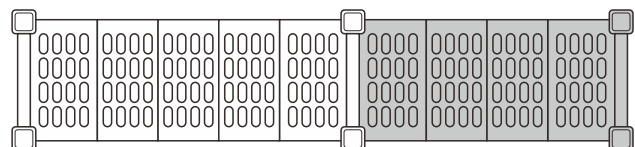

Bacis Unit

Add-on Unit

Mobile Unit

Assembling the 5" with brake caster on the basic unit (two casters with brake, two casters without brake)

| Accessories | Name | Art.No. | Size |
|-------------|-------------------------|---------|----------|
| | 5" Swivel without brake | PSC | 127mm/5" |
| | 5" Swivel with brake | PSW | 127mm/5" |

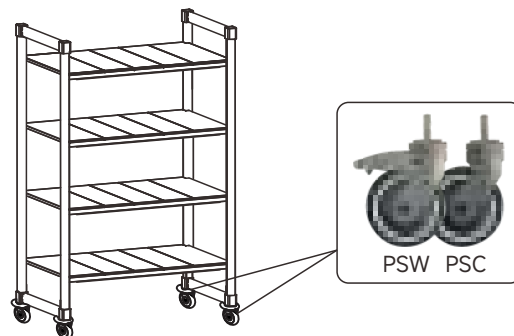



Corner Unit

Using the corner connectors to the basic unit to form the corner unit.

U-shaped Unit

For maximum use of space, it consists of two basic units and one add-on unit.

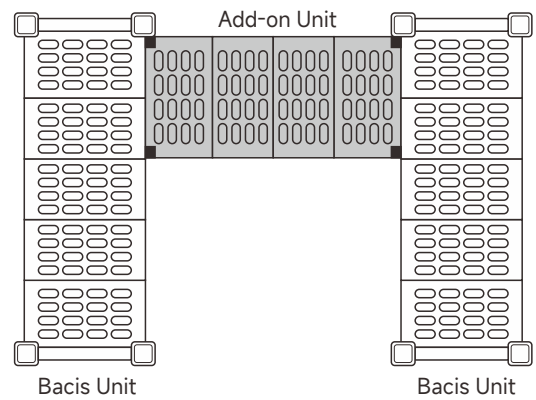
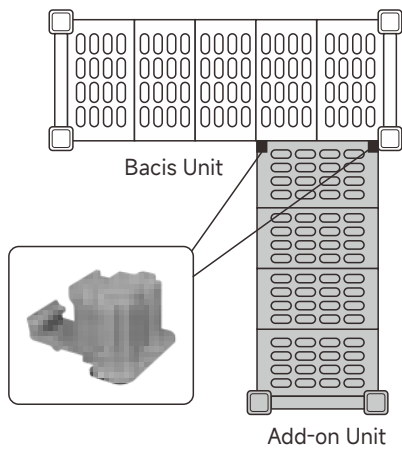

| Accessories | Name | Art.No. |
|-------------|-------------------|---------|
| | Corner connectors | CCC |

Composite Shelving

1600^{64"}_{mm}
Vented Starter Units 

| Width | Length | 760 ^{30"} _{mm} | 910 ^{36"} _{mm} | 1060 ^{42"} _{mm} | 1220 ^{48"} _{mm} | 1370 ^{54"} _{mm} | 1525 ^{60"} _{mm} | 1825 ^{72"} _{mm} |
|----------------------------------|---------|----------------------------------|----------------------------------|-----------------------------------|-----------------------------------|-----------------------------------|-----------------------------------|-----------------------------------|
| 455 ^{18"} _{mm} | Art.No. | CSU301864 | CSU361864 | CSU421864 | CSU481864 | CSU541864 | CSU601864 | CSU721864 |
| 530 ^{21"} _{mm} | Art.No. | CSU302164 | CSU362164 | CSU422164 | CSU482164 | CSU542164 | CSU602164 | CSU722164 |
| 610 ^{24"} _{mm} | Art.No. | CSU302464 | CSU362464 | CSU422464 | CSU482464 | CSU542464 | CSU602464 | CSU722464 |

1800^{72"}_{mm}
Vented Starter Units 

| Width | Length | 760 ^{30"} _{mm} | 910 ^{36"} _{mm} | 1060 ^{42"} _{mm} | 1220 ^{48"} _{mm} | 1370 ^{54"} _{mm} | 1525 ^{60"} _{mm} | 1825 ^{72"} _{mm} |
|----------------------------------|---------|----------------------------------|----------------------------------|-----------------------------------|-----------------------------------|-----------------------------------|-----------------------------------|-----------------------------------|
| 455 ^{18"} _{mm} | Art.No. | CSU301872 | CSU361872 | CSU421872 | CSU481872 | CSU541872 | CSU601872 | CSU721872 |
| 530 ^{21"} _{mm} | Art.No. | CSU302172 | CSU362172 | CSU422172 | CSU482172 | CSU542172 | CSU602172 | CSU722172 |
| 610 ^{24"} _{mm} | Art.No. | CSU302472 | CSU362472 | CSU422472 | CSU482472 | CSU542472 | CSU602472 | CSU722472 |

2000^{80"}_{mm}
Vented Starter Units 

| Width | Length | 760 ^{30"} _{mm} | 910 ^{36"} _{mm} | 1060 ^{42"} _{mm} | 1220 ^{48"} _{mm} | 1370 ^{54"} _{mm} | 1525 ^{60"} _{mm} | 1825 ^{72"} _{mm} |
|----------------------------------|---------|----------------------------------|----------------------------------|-----------------------------------|-----------------------------------|-----------------------------------|-----------------------------------|-----------------------------------|
| 455 ^{18"} _{mm} | Art.No. | CSU301880 | CSU361880 | CSU421880 | CSU481880 | CSU541880 | CSU601880 | CSU721880 |
| 530 ^{21"} _{mm} | Art.No. | CSU302180 | CSU362180 | CSU422180 | CSU482180 | CSU542180 | CSU602180 | CSU722180 |
| 610 ^{24"} _{mm} | Art.No. | CSU302480 | CSU362480 | CSU422480 | CSU482480 | CSU542480 | CSU602480 | CSU722480 |

Composite Shelving

1600^{64"}mm
Vented Starter Add-on Units 

| Width | Length | 760 ^{30"} mm | 910 ^{36"} mm | 1060 ^{42"} mm | 1220 ^{48"} mm | 1370 ^{54"} mm | 1525 ^{60"} mm | 1825 ^{72"} mm |
|-----------------------|---------|-----------------------|-----------------------|------------------------|------------------------|------------------------|------------------------|------------------------|
| 455 ^{18"} mm | Art.No. | CSA301864 | CSA361864 | CSA421864 | CSA481864 | CSA541864 | CSA601864 | CSA721864 |
| 530 ^{21"} mm | Art.No. | CSA302164 | CSA362164 | CSA422164 | CSA482164 | CSA542164 | CSA602164 | CSA722164 |
| 610 ^{24"} mm | Art.No. | CSA302464 | CSA362464 | CSA422464 | CSA482464 | CSA542464 | CSA602464 | CSA722464 |

1800^{72"}mm
Vented Starter Add-on Units 

| Width | Length | 760 ^{30"} mm | 910 ^{36"} mm | 1060 ^{42"} mm | 1220 ^{48"} mm | 1370 ^{54"} mm | 1525 ^{60"} mm | 1825 ^{72"} mm |
|-----------------------|---------|-----------------------|-----------------------|------------------------|------------------------|------------------------|------------------------|------------------------|
| 455 ^{18"} mm | Art.No. | CSA301872 | CSA361872 | CSA421872 | CSA481872 | CSA541872 | CSA601872 | CSA721872 |
| 530 ^{21"} mm | Art.No. | CSA302172 | CSA362172 | CSA422172 | CSA482172 | CSA542172 | CSA602172 | CSA722172 |
| 610 ^{24"} mm | Art.No. | CSA302472 | CSA362472 | CSA422472 | CSA482472 | CSA542472 | CSA602472 | CSA722472 |

2000^{80"}mm
Vented Starter Add-on Units 

| Width | Length | 760 ^{30"} mm | 910 ^{36"} mm | 1060 ^{42"} mm | 1220 ^{48"} mm | 1370 ^{54"} mm | 1525 ^{60"} mm | 1825 ^{72"} mm |
|-----------------------|---------|-----------------------|-----------------------|------------------------|------------------------|------------------------|------------------------|------------------------|
| 455 ^{18"} mm | Art.No. | CSA301880 | CSA361880 | CSA421880 | CSA481880 | CSA541880 | CSA601880 | CSA721880 |
| 530 ^{21"} mm | Art.No. | CSA302180 | CSA362180 | CSA422180 | CSA482180 | CSA542180 | CSA602180 | CSA722180 |
| 610 ^{24"} mm | Art.No. | CSA302480 | CSA362480 | CSA422480 | CSA482480 | CSA542480 | CSA602480 | CSA722480 |

Composite Shelving

1600^{64"}mm
Solid Starter Units 

| Width | Length | 760 ^{30"} mm | 910 ^{36"} mm | 1060 ^{42"} mm | 1220 ^{48"} mm | 1370 ^{54"} mm | 1525 ^{60"} mm | 1825 ^{72"} mm |
|-----------------------|---------|-----------------------|-----------------------|------------------------|------------------------|------------------------|------------------------|------------------------|
| 455 ^{18"} mm | Art.No. | CSS301864 | CSS361864 | CSS421864 | CSS481864 | CSS541864 | CSS601864 | CSS721864 |
| 530 ^{21"} mm | Art.No. | CSS302164 | CSS362164 | CSS422164 | CSS482164 | CSS542164 | CSS602164 | CSS722164 |
| 610 ^{24"} mm | Art.No. | CPSS302464 | CSS362464 | CSS422464 | CSS482464 | CSS542464 | CSS602464 | CSS722464 |

1800^{72"}mm
Solid Starter Units 

| Width | Length | 760 ^{30"} mm | 910 ^{36"} mm | 1060 ^{42"} mm | 1220 ^{48"} mm | 1370 ^{54"} mm | 1525 ^{60"} mm | 1825 ^{72"} mm |
|-----------------------|---------|-----------------------|-----------------------|------------------------|------------------------|------------------------|------------------------|------------------------|
| 455 ^{18"} mm | Art.No. | CSS301872 | CSS361872 | CSS421872 | CSS481872 | CSS541872 | CSS601872 | CSS721872 |
| 530 ^{21"} mm | Art.No. | CSS302172 | CSS362172 | CSS422172 | CSS482172 | CSS542172 | CSS602172 | CSS722172 |
| 610 ^{24"} mm | Art.No. | CSS302472 | CSS362472 | CSS422472 | CSS482472 | CSS542472 | CSS602472 | CSS722472 |

2000^{80"}mm
Solid Starter Units 

| Width | Length | 760 ^{30"} mm | 910 ^{36"} mm | 1060 ^{42"} mm | 1220 ^{48"} mm | 1370 ^{54"} mm | 1525 ^{60"} mm | 1825 ^{72"} mm |
|-----------------------|---------|-----------------------|-----------------------|------------------------|------------------------|------------------------|------------------------|------------------------|
| 455 ^{18"} mm | Art.No. | CSS301880 | CSS361880 | CSS421880 | CSS481880 | CSS541880 | CSS601880 | CSS721880 |
| 530 ^{21"} mm | Art.No. | CSS302180 | CSS362180 | CSS422180 | CSS482180 | CSS542180 | CSS602180 | CSS722180 |
| 610 ^{24"} mm | Art.No. | CSS302480 | CSS362480 | CSS422480 | CSS482480 | CSS542480 | CSS602480 | CSS722480 |

Composite Shelving

1600^{64"}
mm
Solid Starter Add-on Units 

| Width | Length | 760 ^{30"} mm | 910 ^{36"} mm | 1060 ^{42"} mm | 1220 ^{48"} mm | 1370 ^{54"} mm | 1525 ^{60"} mm | 1825 ^{72"} mm |
|--------------------------|---------|--------------------------|--------------------------|---------------------------|---------------------------|---------------------------|---------------------------|---------------------------|
| 455 ^{18"} mm | Art.No. | CSE301864 | CSE361864 | CSE421864 | CSE481864 | CSE541864 | CSE601864 | CSE721864 |
| 530 ^{21"} mm | Art.No. | CSE302164 | CSE362164 | CSE422164 | CSE482164 | CSE542164 | CSE602164 | CSE722164 |
| 610 ^{24"} mm | Art.No. | CSE302464 | CSE362464 | CSE422464 | CSE482464 | CSE542464 | CSE602464 | CSE722464 |

1800^{72"}
mm
Solid Starter Add-on Units 

| Width | Length | 760 ^{30"} mm | 910 ^{36"} mm | 1060 ^{42"} mm | 1220 ^{48"} mm | 1370 ^{54"} mm | 1525 ^{60"} mm | 1825 ^{72"} mm |
|--------------------------|---------|--------------------------|--------------------------|---------------------------|---------------------------|---------------------------|---------------------------|---------------------------|
| 455 ^{18"} mm | Art.No. | CSE301872 | CSE361872 | CSE421872 | CSE481872 | CSE541872 | CSE601872 | CSE721872 |
| 530 ^{21"} mm | Art.No. | CSE302172 | CSE362172 | CSE422172 | CSE482172 | CSE542172 | CSE602172 | CSE722172 |
| 610 ^{24"} mm | Art.No. | CSE302472 | CSE362472 | CSE422472 | CSE482472 | CSE542472 | CSE602472 | CSE722472 |

2000^{80"}
mm
Solid Starter Add-on Units 

| Width | Length | 760 ^{30"} mm | 910 ^{36"} mm | 1060 ^{42"} mm | 1220 ^{48"} mm | 1370 ^{54"} mm | 1525 ^{60"} mm | 1825 ^{72"} mm |
|--------------------------|---------|--------------------------|--------------------------|---------------------------|---------------------------|---------------------------|---------------------------|---------------------------|
| 455 ^{18"} mm | Art.No. | CSE301880 | CSE361880 | CSE421880 | CSE481880 | CSE541880 | CSE601880 | CSE721880 |
| 530 ^{21"} mm | Art.No. | CSE302180 | CSE362180 | CSE422180 | CSE482180 | CSE542180 | CSE602180 | CSE722180 |
| 610 ^{24"} mm | Art.No. | CSE302480 | CSE362480 | CSE422480 | CSE482480 | CSE542480 | CSE602480 | CSE722480 |

Epoxy Wire Shelving

Epoxy Wire Shelving

- Providing the ideal storage solution: epoxy mesh multiple sizes available.
- Open wire construction allows a free circulation of air.
- Open design allows greater visibility of stored items which is convenient to check.
- Different shapes are available based on different circumstances.
- Adjustable to various heights.
- Each shelf supports up to 250kgs, without casters.
- Color: blue, green, black, silver.

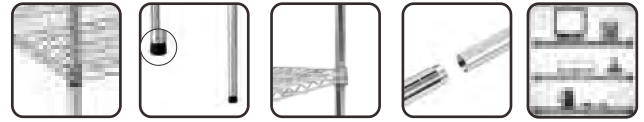

Assemble easily Adjust simply Adjust efficiently Assemble easily Use variously



1600mm Height

| Art.No | Size LxWxH(mm) |
|----------|----------------|
| EN241863 | 610X455X1600 |
| EN301863 | 760X455X1600 |
| EN361863 | 910X455X1600 |
| EN421863 | 1060X455X1600 |
| EN481863 | 1220X455X1600 |
| EN541863 | 1370X455X1600 |
| EN601863 | 1525X455X1600 |
| EN721863 | 1825X455X1600 |
| EN242163 | 610X530X1600 |
| EN302163 | 760X530X1600 |
| EN362163 | 910X530X1600 |
| EN422163 | 1060X530X1600 |

| Art.No | Size LxWxH(mm) |
|----------|----------------|
| EN482163 | 1220X530X1600 |
| EN542163 | 1370X530X1600 |
| EN602163 | 1525X530X1600 |
| EN722163 | 1825X530X1600 |
| EN242463 | 610X610X1600 |
| EN302463 | 760X610X1600 |
| EN362463 | 910X610X1600 |
| EN422463 | 1060X610X1600 |
| EN482463 | 1220X610X1600 |
| EN542463 | 1370X610X1600 |
| EN602463 | 1525X610X1600 |
| EN722463 | 1825X610X1600 |

Note: This item requires a MOQ.

1800mm Height

| Art.No | Size LxWxH(mm) |
|----------|----------------|
| EN241871 | 610X455X1800 |
| EN301871 | 760X455X1800 |
| EN361871 | 910X455X1800 |
| EN421871 | 1060X455X1800 |
| EN481871 | 1220X455X1800 |
| EN541871 | 1370X455X1800 |
| EN601871 | 1525X455X1800 |
| EN721871 | 1825X455X1800 |
| EN242171 | 610X530X1800 |
| EN302171 | 760X530X1800 |
| EN362171 | 910X530X1800 |
| EN422171 | 1060X530X1800 |

| Art.No | Size LxWxH(mm) |
|----------|----------------|
| EN482171 | 1220X530X1800 |
| EN542171 | 1370X530X1800 |
| EN602171 | 1525X530X1800 |
| EN722171 | 1825X530X1800 |
| EN242471 | 610X610X1800 |
| EN302471 | 760X610X1800 |
| EN362471 | 910X610X1800 |
| EN422471 | 1060X610X1800 |
| EN482471 | 1220X610X1800 |
| EN542471 | 1370X610X1800 |
| EN602471 | 1525X610X1800 |
| EN722471 | 1825X610X1800 |

S/S Shelving / Chromed Shelving

S/S Shelving / Chromed Shelving

- Providing the ideal storage solution; S/S/ Chromed mesh, multiple sizes available.
- Open wire construction allows a free circulation of air.
- Open design allows greater visibility of stored items which is convenient to check.
- Different shapes are available based on different circumstances.
- Adjustable to various heights easily.
- Each shelf supports up to 250kgs without casters.



Assemble easily Adjust simply Adjust efficiently Assemble easily Use variously

S/S Shelving / Chromed Shelving

Caster

| Art.No. | JW-5S | JW-5SC |
|---------|----------------------|---------------------------------|
| Name | 5" Universal Casters | 5" Universal Casters With Brake |
| Size | 127mm / 5" | 127mm / 5" |

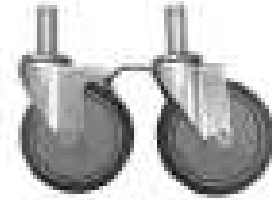

S/S Shelving

1600mm Height

| Art.No | Size LxWxH(mm) |
|----------|----------------|
| SN241863 | 610X455X1600 |
| SN301863 | 760X455X1600 |
| SN361863 | 910X455X1600 |
| SN421863 | 1060X455X1600 |
| SN481863 | 1220X455X1600 |
| SN541863 | 1370X455X1600 |
| SN601863 | 1525X455X1600 |
| SN721863 | 1825X455X1600 |
| SN242163 | 610X530X1600 |
| SN302163 | 760X530X1600 |
| SN362163 | 910X530X1600 |
| SN422163 | 1060X530X1600 |

| Art.No | Size LxWxH(mm) |
|----------|----------------|
| SN482163 | 1220X530X1600 |
| SN542163 | 1370X530X1600 |
| SN602163 | 1525X530X1600 |
| SN722163 | 1825X530X1600 |
| SN242463 | 610X610X1600 |
| SN302463 | 760X610X1600 |
| SN362463 | 910X610X1600 |
| SN422463 | 1060X610X1600 |
| SN482463 | 1220X610X1600 |
| SN542463 | 1370X610X1600 |
| SN602463 | 1525X610X1600 |
| SN722463 | 1825X610X1600 |

1800mm Height

| Art.No | Size LxWxH(mm) |
|----------|----------------|
| SN241871 | 610X455X1800 |
| SN301871 | 760X455X1800 |
| SN361871 | 910X455X1800 |
| SN421871 | 1060X455X1800 |
| SN481871 | 1220X455X1800 |
| SN541871 | 1370X455X1800 |
| SN601871 | 1525X455X1800 |
| SN721871 | 1825X455X1800 |
| SN242171 | 610X530X1800 |
| SN302171 | 760X530X1800 |
| SN362171 | 910X530X1800 |
| SN422171 | 1060X530X1800 |

| Art.No | Size LxWxH(mm) |
|----------|----------------|
| SN482171 | 1220X530X1800 |
| SN542171 | 1370X530X1800 |
| SN602171 | 1525X530X1800 |
| SN722171 | 1825X530X1800 |
| SN242471 | 610X610X1800 |
| SN302471 | 760X610X1800 |
| SN362471 | 910X610X1800 |
| SN422471 | 1060X610X1800 |
| SN482471 | 1220X610X1800 |
| SN542471 | 1370X610X1800 |
| SN602471 | 1525X610X1800 |
| SN722471 | 1825X610X1800 |

Chromed Shelving

1600mm Height

| Art.No | Size LxWxH(mm) |
|----------|----------------|
| CN241863 | 610X455X1600 |
| CN301863 | 760X455X1600 |
| CN361863 | 910X455X1600 |
| CN421863 | 1060X455X1600 |
| CN481863 | 1220X455X1600 |
| CN541863 | 1370X455X1600 |
| CN601863 | 1525X455X1600 |
| CN721863 | 1825X455X1600 |
| CN242163 | 610X530X1600 |
| CN302163 | 760X530X1600 |
| CN362163 | 910X530X1600 |
| CN422163 | 1060X530X1600 |

| Art.No | Size LxWxH(mm) |
|----------|----------------|
| CN482163 | 1220X530X1600 |
| CN542163 | 1370X530X1600 |
| CN602163 | 1525X530X1600 |
| CN722163 | 1825X530X1600 |
| CN242463 | 610X610X1600 |
| CN302463 | 760X610X1600 |
| CN362463 | 910X610X1600 |
| CN422463 | 1060X610X1600 |
| CN482463 | 1220X610X1600 |
| CN542463 | 1370X610X1600 |
| CN602463 | 1525X610X1600 |
| CN722463 | 1825X610X1600 |

1800mm Height

| Art.No | Size LxWxH(mm) |
|----------|----------------|
| CN241871 | 610X455X1800 |
| CN301871 | 760X455X1800 |
| CN361871 | 910X455X1800 |
| CN421871 | 1060X455X1800 |
| CN481871 | 1220X455X1800 |
| CN541871 | 1370X455X1800 |
| CN601871 | 1525X455X1800 |
| CN721871 | 1825X455X1800 |
| CN242171 | 610X530X1800 |
| CN302171 | 760X530X1800 |
| CN362171 | 910X530X1800 |
| CN422171 | 1060X530X1800 |

| Art.No | Size LxWxH(mm) |
|----------|----------------|
| CN482171 | 1220X530X1800 |
| CN542171 | 1370X530X1800 |
| CN602171 | 1525X530X1800 |
| CN722171 | 1825X530X1800 |
| CN242471 | 610X610X1800 |
| CN302471 | 760X610X1800 |
| CN362471 | 910X610X1800 |
| CN422471 | 1060X610X1800 |
| CN482471 | 1220X610X1800 |
| CN542471 | 1370X610X1800 |
| CN602471 | 1525X610X1800 |
| CN722471 | 1825X610X1800 |

Note: Some sizes require a MOQ.

Wine Storage Rack

Wine Storage Rack

- Standard four-tier of 15" spacing distribution
- Each shelf equips with 4 stencils according to different sizes of bottles to separate different sizes of storage space.
- Grid structure ensures the flow of air which is helpful for temperature controlling.
- The sealed back and side panels can keep the bottles safe and prevent accidents.
- Front door with locks is for security.
- Two different sizes are available.

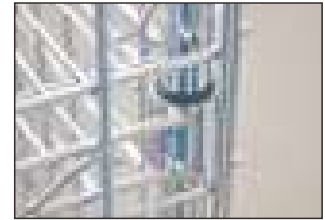
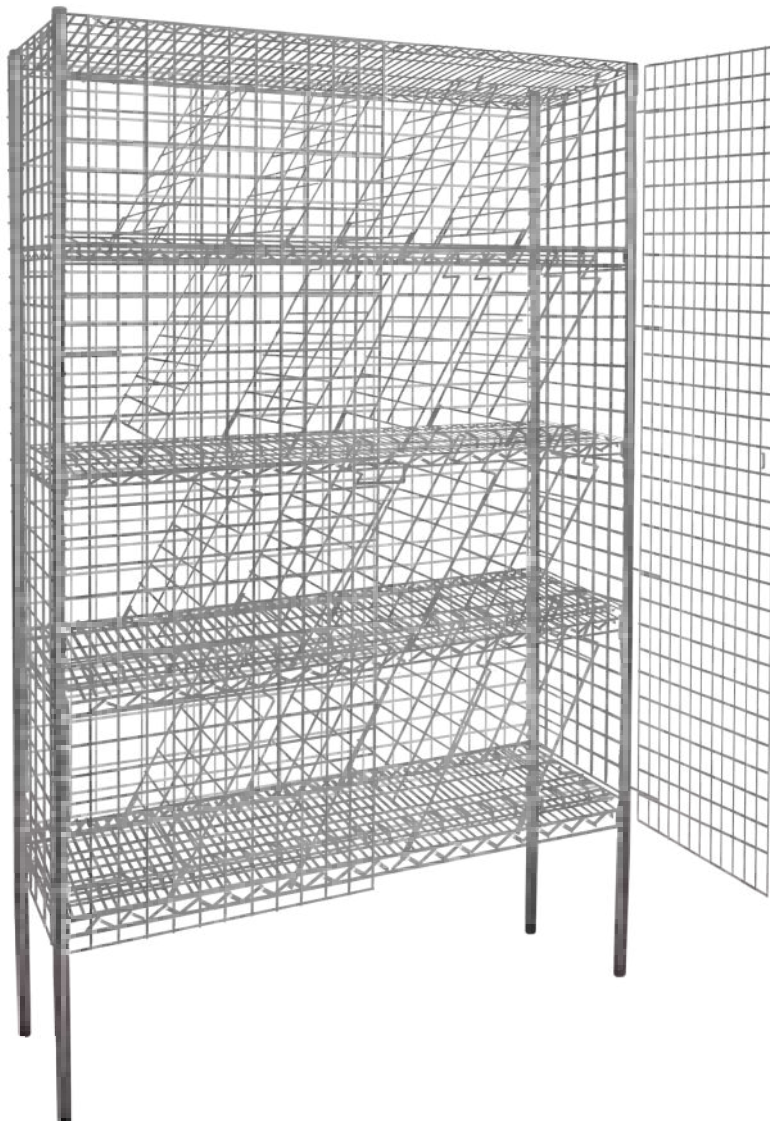

Exquisite Workmanship



Movable & Foldable

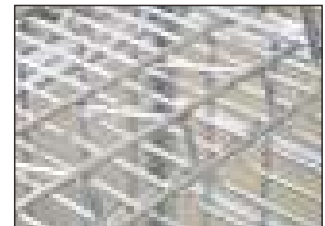

Maintain te 10° tilt up

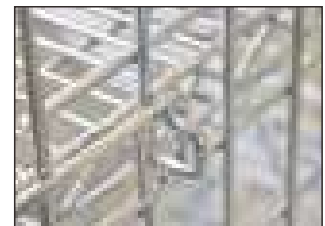

With safety lock

| | | |
|-------------------|--------------------------------|---------------------------------|
| Art.No. | JW-WSS3614 | JW-WSS4814 |
| Name | 910mm S/S Wine Storage Rack | 1220mm S/S Wine Storage Rack |
| Size | 910x355x1900 mm | 1220x355x1900 mm |
| Material | S/S | S/S |
| Carrying Capacity | 12 boxes | 16 boxes |
| PCS/CTN | 1 | 1 |

GN Pan Trolley

6 Tiers GN Pan Trolley

- Designed to pack GN Pan and transport them.
- Suitable for GN Pan sizes 2/1,1/1,1/2,1/3,2/3 in 65mm depth.
- PVC / TPR wheels are available,2 with brakes.
- M shape layers, its construction is enough strong to support 15kg/shelf.
- Stop lever at diagonal sides, to avoid the pans sliding out.



| Art.No. | JW-RK6 | JW-RK12 | JW-RK6-2 |
|----------|------------------------|------------------------|---------------------------------|
| Name | 6 Tiers GN Pan Trolley | 6 Tiers GN Pan Trolley | 6 Tiers Dual-row GN Pan Trolley |
| Size | 380x550x950 mm | 590x670x950 mm | 740x550x950 mm |
| Material | 201 | 201 | 201 |
| Remark | 6 Tiers, for 1/1 GN | 6 Tiers, for 2/1 GN | 6 Tiers, for 1/1 GN |
| PCS/CTN | 1 | 1 | 1 |

6 Tiers GN Pan Trolley with table top

- Designed to pack GN Pan and offer a table top
- Suitable for GN Pan sizes 2/1,1/1,1/2,1/3,2/3 in 65mm depth
- PVC / TPR wheels are available,2 with brakes
- M shape layers, its construct to support 15kg/shelf
- Stop lever at diagonal sides, to avoid the pans sliding out



| Art.No. | JW-RKC6 | JW-RKC12 | JW-RKC6-2 |
|----------|---------------------------------------|---------------------------------------|--|
| Name | 6 Tiers GN Pan Trolley with table top | 6 Tiers GN Pan Trolley with table top | 6 Tiers Dual-row GN Pan Trolley with table top |
| Size | 380x550x950 mm | 590x670x1025 mm | 740x550x950 mm |
| Material | 201 | 201 | 201 |
| Remark | 6 Tiers, for 1/1 GN | 6 Tiers, for 2/1 GN | 6 Tiers, for 1/1 GN |
| PCS/CTN | 1 | 1 | 1 |

GN Pan Trolley

15 Tiers S/S Nesting GN Pan Trolley / Sheet Pan Trolley

-In order to save space during storage trolleys can be pushed into one another.

GN Pan 1/1with 15 layers- interspaced at 80mm.

-Tray locks on either side.

-Fitted with four castors of which two have brakes.

-Flatpack Delivery.

NEW!



Stackable structure for space saving

| Art.No. | JW-GNZK15 | JW-GNZK30 | JW-EUZK15 |
|----------|-------------------------------------|-------------------------------------|---|
| Name | 15 Tiers S/S Nesting GN Pan Trolley | 15 Tiers S/S Nesting GN Pan Trolley | 15 Tiers S/S Nesting Sheet Pan Trolley |
| Size | 380x550x1710 mm | 590x670x1710 mm | 470x620x1710 mm |
| Material | 201 | 201 | 201 |
| Remark | 15 Tiers, for 1/1 GN | 15 Tiers, for 2/1 GN | 15 Tiers, baking trolley for 40x60 pans |
| PCS/CTN | 1 | 1 | 1 |

GN Pan Trolley

16 Tiers GN Pan Trolley



- Gastronome trolleys ideal for a wide range of food transport, serving and storage tasks within the catering industry.
- 100% avoid rails-dropping by strong spot welding.
- Fitted with GN Pan sizes 1/1, 1/2 , 1/3 and 2/1 for 6 tiers to 20tiers.
- Single or double row designs will meet your different demands.
- Single or double row designs will meet your different demands.
- Stable layers option for supporton heavy duty service, max loading 15KG/shelf.
- Tray locks on either side for anti-sliding the pans.
- Smooth edge of each bars caring your hand.
- Fitted with 4 pcs TPR / PVC swivel castors, 2 with brakes.



| Art.No. | JW-RK16 | JW-RK32 | JW-RK16-2 |
|----------|-------------------------|-------------------------|----------------------------------|
| Name | 16 Tiers GN Pan Trolley | 16 Tiers GN Pan Trolley | 16 Tiers Dual-row GN Pan Trolley |
| Size | 380x550x1700 mm | 590x670x1700 mm | 740x550x1730 mm |
| Material | 201 | 201 | 201 |
| Remark | 16 Tiers, for 1/1 GN | 16 Tiers, for 2/1 GN | 16 Tiers, for 1/1 GN |
| PCS/CTN | 1 | 1 | 1 |

Sheet Pan Trolley

Sheet Pan Trolley

- In order to pack and storage the baking pans.
- Tray locks on either side.
- Max loading 150kg.
- Smooth edge without sharp burs , safety for used.
- Customized height from 12 tiers to 20 tiers.
- Layers fixed on the tube by strong spot welding ,stable and durable.
- Fitted with four castors of which two have brakes.
- Flat pack delivery.

NEW!



Europe

| Art.No. | JW-EUSK15 | JW-EUSK16 | JW-EUSK30 | JW-EUSK32 |
|----------|----------------------------|----------------------------|----------------------------|----------------------------|
| Name | 15 Tiers Sheet Pan Trolley | 16 Tiers Sheet Pan Trolley | 15 Tiers Sheet Pan Trolley | 16 Tiers Sheet Pan Trolley |
| Size | 466x620x1700 mm | 466x620x1700 mm | 670x820x1700 mm | 670x820x1700 mm |
| Material | 201 | 201 | 201 | 201 |
| Remark | 15 Tiers, for 40x60 Pans | 15 Tiers, for 40x60 Pans | 15 Tiers, for 40x60 Pans | 15 Tiers, for 40x60 Pans |
| PCS/CTN | 1 | 1 | 1 | 1 |

US

| Art.No. | JW-AMSK15 | JW-AMSK16 | JW-AMSK30 | JW-AMSK32 |
|----------|----------------------------|----------------------------|----------------------------|----------------------------|
| Name | 15 Tiers Sheet Pan Trolley | 16 Tiers Sheet Pan Trolley | 15 Tiers Sheet Pan Trolley | 16 Tiers Sheet Pan Trolley |
| Size | 680x518x1700 mm | 680x518x1700 mm | 720x940x1700 mm | 720x940x1700 mm |
| Material | 201 | 201 | 201 | 201 |
| Remark | 15 Tiers, for 46x66 Pans | 15 Tiers, for 46x66 Pans | 15 Tiers, for 46x66 Pans | 15 Tiers, for 46x66 Pans |
| PCS/CTN | 1 | 1 | 1 | 1 |

Faucet Products



Mounted Faucet



Workboard Faucet



Pantry Faucets



Dipperwell Bowl



Wall Mounted Retractable
Hose Reel

Mounted Faucet

Easy Install Pre-rinse Unit

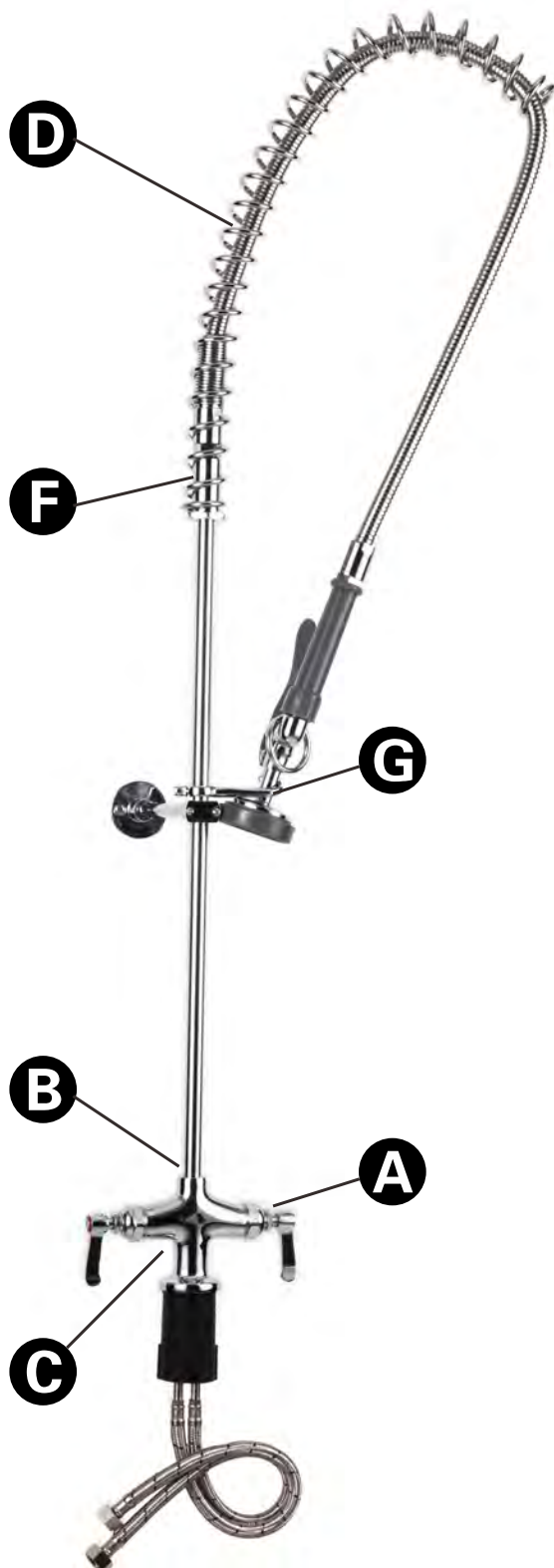

JW-PS13B

- A** CARTRIDGES
Interchangeable
Self-contained and easily replaced
Ceramic and compression
- B** EASY INSTALL
Patented design
Unique "pop-and lock" riser connection
that takes as little as 10 minutes to install
- C** FAUCETS
Forged one-piece base faucet eliminated leaks
Copper layer over casting makes smoother surface
Thick chrome plating
- D** HOSES
Stainless steel hoses with double interlocked
covers for long life
Sealed ends prevent tears
Vinyl nylon reinforced inner hose tested to
1200PSL
- E** PACKAGING
Pre-assembled parts are ready for quick
installation
Fewer parts to misplace
- F** SPRING
Specially designed spring reinforced at
the stress point where hose connects.
Protects and extends life of hose
- G** SPRAY VALVES
Significant water-saving with low-flow
rates
Uncompromising performance
Tested to over 1.5 million cycles

Mounted Faucet



| | |
|----------|-----------------------|
| Art.No. | JW-PS13 |
| Ref.No | B-0113 |
| Material | Brass(Plastic) |
| Notes | Spare parts available |
| PCS/CTN | 1 |

4" Deck Mounted Faucet



| | |
|----------|-----------------------|
| Art.No. | JW-PS38 |
| Ref.No | B-2338 |
| Material | Brass(Plastic) |
| Notes | Spare parts available |
| PCS/CTN | 1 |

4" Center Deck Faucet



| | |
|----------|-----------------------|
| Art.No. | JW-PS33 |
| Ref.No | B-0133 |
| Material | Brass(Plastic) |
| Notes | Spare parts available |
| PCS/CTN | 1 |

8" Center Wall Mounted Faucet



| | |
|----------|-----------------------|
| Art.No. | JW-PS18 |
| Ref.No | B-0118 |
| Material | Brass(Plastic) |
| Notes | Spare parts available |
| PCS/CTN | 1 |

8" Center Wall Faucet

Pot and Kettle Filler

Pot and Kettle Filler

- Chrome plated brass faucets stainless steel hoses with hook outlets are available.
- Wall Mounted Pot and Kettle Filler has hot and cold taps 8" (203mm).
- Hook nozzle outlet with automatic self-generating valve and hook.
- 1/2" NPT female inlets.
- Built in check valves to prevent crossflow of water.
- Hold down ring for continuous flowing.

| Art.No. | JW-PK05 | JW-PK10 |
|----------|------------------------------|--------------------------|
| Name | Single Pot and Kettle Filler | 8" Pot and Kettle Filler |
| Ref.No | B-0605 | B-0610 |
| Material | Brass(Plastic) | Brass(Plastic) |
| Notes | Spare parts available | Spare parts available |
| PCS/CTN | 1 | 1 |



JW-PK05



JW-PK10

Pot Filler Faucet

- 18" (457 mm) double joint nozzle
- Insulated on-off volume control grip on tip of nozzle
- Wall mounting hole I.D.: 25mm

| Art.No. | JW-PF0592 |
|----------|-----------------------|
| Name | Pot Filler Faucet |
| Material | Brass(Plastic) |
| Notes | Spare parts available |
| PCS/CTN | 1 |



JW-PF0592

Wall Mounted Retractable Hose Reel

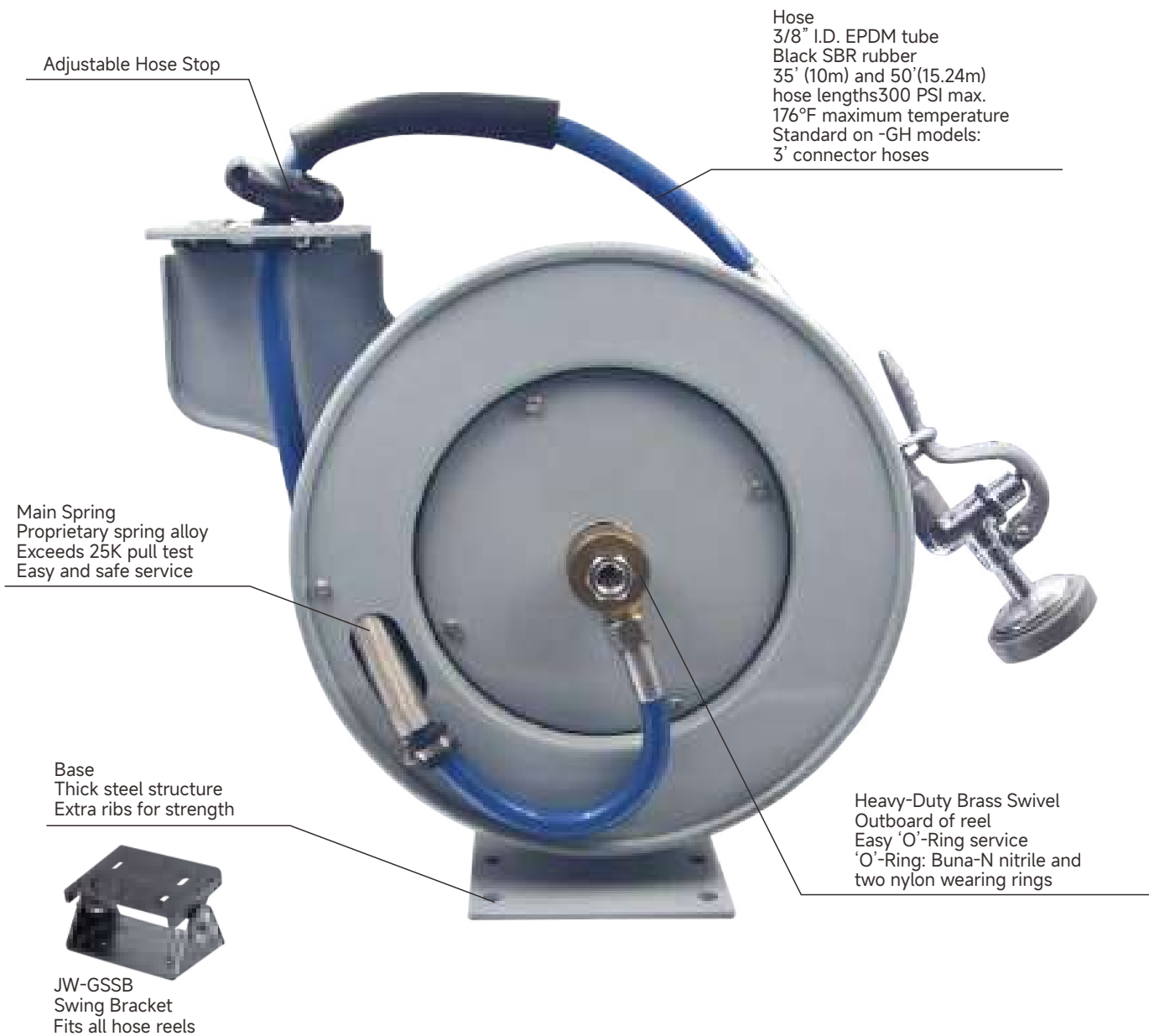

| Art.No. | JW-GS03 | JW-GS03-A | JW-GS05 | JW-GS06 | JW-GS07 |
|----------|--|--|----------------------------|-----------------------------------|---------------------------------------|
| Name | Economic Version Open Retractable Hose Reel | 15M Economic Version Open Retractable Hose Reel | Open Retractable Hose Reel | Open S/S Retractable Hose Reel | Enclosed S/S Retractable Hose Reel |
| Tef.No. | B-1403 | B-1403 | B-7232-01 | B-7132-01 | B-7122-C01 |
| Length | 10.5 M | 15 M | 10.5 M | 10.5 M | 9 M |
| Material | Brass/Steel/Plastic | Brass/Steel/Plastic | Brass/Steel/Plastic | Brass/Steel/Plastic | Brass/Steel/Plastic |
| Notes | Spare parts available | Spare parts available | Spare parts available | Spare parts available | Spare parts available |
| PCS/CTN | 1 | 1 | 1 | 1 | 1 |

Workboard Faucet



JW-PS123
8" Deck-Mounted Workboard Faucet

- 12" (305mm) swing nozzles
- 1/2" standard pipe thread, removable seats, chrome plated escutcheon
- Deck mounting holes I.D.: 25mm X 2, 8" (203mm) center



JW-PS113
4" Deck-Mounted Workboard Faucet

- 12" (305mm) swing nozzles
- 1/2" standard pipe thread, removable seats, chrome plated escutcheon
- Deck mounting holes I.D.: 25mm X 2, 4" (102mm) center



JW-PS142
8" Deck-Mounted Workboard Faucet

- Swing gooseneck with 5-11/16"(145mm) spread
- 1/2" standard pipe thread, removable seats, chrome plated escutcheon
- Deck mounting holes I.D.: 25mmX2, 8"(203mm) center



JW-PS141
4" Deck-Mounted Workboard Faucet

- Swing gooseneck with 5-11/16"(145mm) spread
- 1/2" standard pipe thread, removable seats, chrome plated escutcheon
- Deck mounting holes I.D.: 25mmX2, 4"(102mm) center



JW-PS132
8" Deck-Mounted Workboard Faucet

- 18"(457mm) double-joint nozzles
- 1/2" standard pipe thread, removable seats, chrome plated escutcheon
- Deck mounting holes I.D.: 25mmX2, 8"(203mm) center



JW-PS131
4" Deck-Mounted Workboard Faucet

- 18"(457mm) double-joint nozzles
- 1/2" standard pipe thread, removable seats, chrome plated escutcheon
- Deck mounting holes I.D.: 25mmX2, 4"(102mm) center

Pantry Faucets



JW-PS221
8" Deck-Mounted Mixing Faucet

- Double pantry faucet with 12"(305mm) swing nozzle
- 8"(203mm) centers, lever handles
- 1/2" standard pipe thread, eccentric flanged
- Deck mounting holes I.D.: 25mmX2, 8"(203mm) center

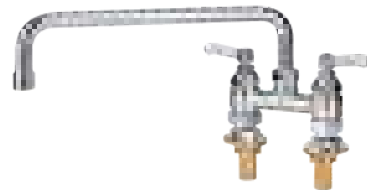

JW-PS225
4" Deck-Mounted Mixing Faucet

- Double pantry faucet with 12"(305mm) swing nozzle
- 4"(102mm) centers, lever handles
- 1/2" standard pipe thread, eccentric flanged
- Deck mounting holes I.D.: 25mmX2, 4"(102mm) center



JW-PS321
8" Deck-Mounted Mixing Faucet

- Swing gooseneck with 5-11/16"(145mm) spread
- 8"(203mm) centers, lever handles
- 1/2" standard pipe thread, eccentric flanged
- Deck mounting holes I.D.: 25mmX2, 8"(203mm) center



JW-PS325
4" Deck-Mounted Mixing Faucet

- Swing gooseneck with 5-11/16"(145mm) spread
- 4"(102mm) centers, lever handles
- 1/2" standard pipe thread, eccentric flanged
- Deck mounting holes I.D.: 25mmX2, 4"(102mm) center



JW-PS245
8" Deck-Mounted Mixing Faucet

- 18"(457mm) double-joint nozzles
- 8"(203mm) centers, lever handles
- 1/2" standard pipe thread, eccentric flanged
- Deck mounting holes I.D.: 25mmX2, 8"(203mm) center



JW-PS248
4" Deck-Mounted Mixing Faucet

- 18"(457mm) double-joint nozzles
- 4"(102mm) centers, lever handles
- 1/2" standard pipe thread, eccentric flanged
- Deck mounting holes I.D.: 25mmX2, 4"(102mm) center

Pantry Faucets



JW-PS201
4" Deck-Mounted Double Mixing Faucet

- 12"(305mm) swing nozzle
- Single hole base faucet with 4"(102mm) spreader unit
- Lever handles, nut and tailpiece furnished for optional 1/4" standard pipe thread connections
- Deck mounting holes I.D.: 35mm



JW-PS206
Deck-Mounted Single Pantry Faucet

- 12"(305mm) swing nozzle
- Lever handle (specify hot or cold)
- 1/2" standard pipe thread male shank
- Deck mounting holes I.D.: 25mm



JW-PS301
4" Deck-Mounted Double Mixing Faucet

- 5-11/16"(145mm) swing gooseneck
- Single hole base faucet with 4"(102mm) spreader unit
- Lever handles, nut and tailpiece furnished for optional 1/4" standard pipe thread connections
- Deck mounting holes I.D.: 35mm



JW-PS306
Deck-Mounted Single Pantry Faucet

- 5-11/16"(145mm) swing gooseneck
- Lever handle (specify hot or cold)
- 1/2" standard pipe thread male shank
- Deck mounting holes I.D.: 25mm



JW-PS250
4" Deck-Mounted Double Mixing Faucet

- 18"(457mm) double-joint nozzles
- Single hole base faucet with 4"(102mm) spreader unit
- Lever handles, nut and tailpiece furnished for optional 1/4" standard pipe thread connections
- Deck mounting holes I.D.: 35mm



JW-PS255
Deck-Mounted Single Pantry Faucet

- 18"(457mm) double-joint nozzles
- Lever handle (specify hot or cold)
- 1/2" standard pipe thread male shank
- Deck mounting holes I.D.: 25mm

Workboard and Pantry Faucets

According to user demand,
matching of different base
faucets and nozzles



**JW-PS110-LN
Workboard Faucet**



**JW-PS120-LN
Workboard Faucet**

- Deck mounted
- Forged brass body
- Removable seats
- 6-1/2"(165mm) long,
2"(51mm) wide chrome
plated escutcheon
4"(102mm) centers

- Deck mounted
- Forged brass body
- Removable seats
- Removable seats
10-1/2"(267mm) long,
2"(51mm) wide chrome
plated escutcheon
8"(203mm) centers

| NOZZLES | MODEL | L/SIZE | MODEL | MODEL |
|---|-----------|---|----------|----------|
|  | JW-PS-021 | 8" (203mm) | — | — |
| | JW-PS-016 | 12" (305mm) | JW-PS113 | JW-PS123 |
|  | JW-PS-020 | Black Length: 6"(152mm) Front Length: 12"(305mm) Total Length: 18"(457mm) | JW-PS131 | JW-PS132 |
|  | JW-PS-019 | 5-11/16" (145mm) | JW-PS141 | JW-PS142 |



JW-PS220-LN
Swivel Base Faucet



JW-PS225-LN
Swivel Base Faucet



JW-PS200-LN
Swivel Base Faucet



JW-PS205-LN
Single Pantry Faucet



JW-PS210-LN
Swivel Base Faucet

Deck mixing
faucet-swivel
Lever handles
8"(203 mm) centers

Deck mixing
faucet-swivel
Lever handles
4"(102 mm) centers

Deck mixing faucet,
deck-mounted
Lever handles
Deck mounting-
hole:35mm

Single pantry faucet,
deck-mounted
Lever handle
(specify cold or hot)
Deck mounting-
hole:25mm

Deck mounted
mixing faucet
Lever handle
(specify cold or hot)
Wall mounting-
hole:25mm

MODEL

MODEL

MODEL

MODEL

MODEL

JW-PS220

—

—

—

—

JW-PS221

JW-PS225

JW-PS201

JW-PS206

JW-PS211

JW-PS245

JW-PS248

JW-PS250

JW-PS255

JW-PS260

JW-PS321

JW-PS325

JW-PS301

JW-PS306

—

Dipperwell Bowl and Faucet / Waste Valves



JW-DB2282 Dipperwell Bowl and Faucet

- Includes Dipperwell Bowl and Faucet
- Deck mounting hole I.D.: 22mm, -146mm. Attention the clearance between faucet and bowl.



JW-DB2282-01 Dipperwell Faucet

- 5" (168 mm) overall height
- 1-3/8" (35 mm) above table
- 1/16" (1.6 mm) solder inlet
- Deck mounting hole I.D.: 22mm

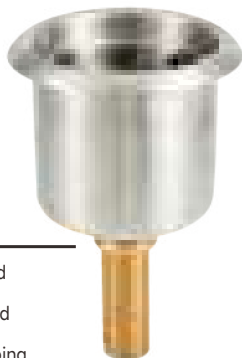

JW-DB2282-02 Dipperwell Bowl

- Keeps ice cream scoops and paddles clean and sanitized,
- Stainless steel internal cup, outer container and tail washer,
- 4" (102 mm) length of 1-1/2" (38 mm) brass tubing,
- Sits flush with tabletop,
- Drains quickly and easily,



JW-WV3952-01 Waste Valve and overflow Assembly

- "01" models include an overflow assembly,
- Handle length: 312mm
- Product length: 720mm, height: 430mm



JW-WV3952 Twist Waste Valves

- Twist rotary waste valves
- Drain adapter
- Valve bodies come standard with 2" outlet
- 3-1/2" (89 mm) sink opening applications

Glass Filler & Glass Rinse

JW-GF-8P & JW-GF-14P Pedestal Deck-Mount Glass Filler

- Push back design
- Blue self-closing Lexan arm
- Volume control adjustable with screwdriver
- 8P 240mm pedestal height (from deck to outlet)
- 14P 355mm pedestal height (from deck to outlet)
- Deck mounting holes I.D.: 25mm



JW-GF-8P-WS & JW-GF-14P-WS Glass Filler Water Station

- 304 stainless steel sink
- Stainless steel drain net
- Push back design
- Blue self-closing Lexan arm
- Volume control adjustable with screwdriver
- 8P 240mm pedestal height (from deck to outlet)
- 14P 235mm pedestal height (from deck to outlet)
- Deck mounting holes I.D.: 265x225mm

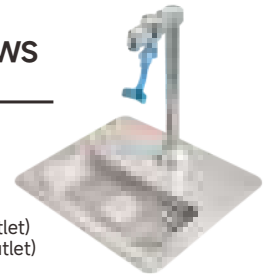

JW-GR13 Glass Rinse

- One-handed operation
- Goblet glass rinse
- Multi-angle water spray hole
- Deck mounting holes I.D.: 158x145mm

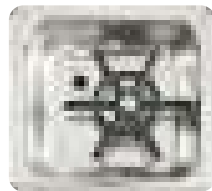

JW-GR13B Glass Rinse

- One-handed operation
- Goblet glass rinse
- Multi-angle water spray hole
- With base, more stable and reliable
- Can be used on the table
- Deck mounting holes I.D.: 158x145mm



JW-GR16 Glass Rinse

- One-handed operation
- Goblet glass rinse
- Multi-angle water spray hole
- Deck mounting holes I.D.: 308x159mm



JW-GR16B Glass Rinse

- One-handed operation
- Goblet glass rinse
- Multi-angle water spray hole
- With base, more stable and reliable
- Can be used on the table
- Deck mounting holes I.D.: 308x159mm



JW-GR1608 Glass Rinse

- One-handed operation
- Multi-angle water spray hole
- Stainless steel drain net
- Hard Size:114mm
- Deck mounting holes I.D.: 400x200mm

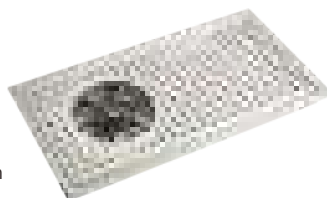

JW-GR2508 Glass Rinse

- One-handed operation
- Multi-angle water spray hole
- Stainless steel drain net
- Hard Size:114mm
- Deck mounting holes I.D.: 615x182mm



Single hole Deck Mount Sensor Faucet

JW-DSF Single hole Deck Mount Sensor Faucet

- Cold/hot/warm water regulation
- Sensing range $\pm 28\text{CM}$
- Optional DC or AC
- Power box self-tapping screws
- Center Mounting Hole: 25mm

NEW!



| | |
|-----------------|--------------------|
| Art.No. | JW-DSF |
| Name | 15x14.5x13.2 cm |
| Induction range | 28CM($\pm 10\%$) |
| Material | Brass(Plastic) |
| PCS/CTN | 1 |

Accessories



Temperature Mixing Valve

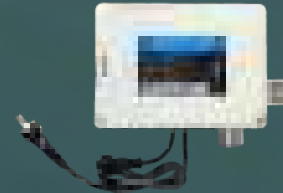

Full-automation Sensor control Module Box
(with battery box)



Cold and Hot water Hose



Flexible Connector Hose



Foot Valve/Service Sink Faucet



NEW!

JW-1827-1 Foot Valve, Single Lever

- Hot Or Cold, Single Lever Control
- Self-Closing
- Rough chrome valve body highly polished chrome foot pedal
- 1/2"NPT female inlets,1/2" NPT Female outlet
- Use with spout bases



NEW!

JW-1829 Deck-mounted gooseneck spout

- 5-1/2" (140 mm) rigid spread
- 11-7/8" (300 mm) high from deck to top
- 5-8/9" (175 mm) clearance from deck to stream regulator outlet
- Deck mounting holes I.D.: 25mm
- Use with foot valve



NEW!

JW-1827-2 Foot Valve, Dual Lever

- Hot Or Cold, dual Lever Control
- Self-Closing
- Rough chrome valve body highly polished chrome foot pedal
- 1/2"NPT female inlets,1/2" NPT Female outlet
- Use with spout bases



NEW!

JW-B0665 Service Sink Faucet

- Wall-mounted faucet
- 8"(203mm) centers, lever handles
- Built-in check valve to prevent cross flow
- Wall bracket support
- 1/2"NPT female inlets,1/2" NPT Female outlet
- Faucet accepts 3/4" threaded hose and pail hook

Faucets Accessories



JW-PS-001
Flex S/Hose



JW-PS-002
Spring overhead



JW-PS-003
Spray Valve



JW-PS-004
Add-on Faucet Unit



JW-PS-005
Wall Mount



JW-PS-006
Deck Mount



JW-PS-007
12-Inch Wall Bracket



JW-PS-008
Button Valve



JW-PS-009
Cold Water Valve



JW-PS-010
Hot Water Valve



JW-PS-011
Valve Handle (Hot)



JW-PS-012
Valve Handle (Cold)



JW-PS-013
Pre-Rise Spray Head



JW-PS-014
Pre-Rise Spray Supply Inlet



JW-PS-015
Faucet Valve



JW-PS-016
Neck of Faucet Unit



JW-PS-017
Straight Brass Tube



JW-PS-018
S Shape Handle



JW-BS-2522
Front Trigger Water Gun



Drink Server

Drink Server

- Keep beverage hot or cold and fresh for hours.
- Suitable for the restaurant's foreground and background.
- Seamless double-wall PE construction and foamed-in-place polyurethane insulation ensures years of reliable service and prevents liquids from seeping walls.
- Molded-in mounting plates prevent latches from pulling out.
- Drip-proof recessed spigot allows for easy accessing and can be easily adjusted without tools.
- Wide service opening accommodates larger cup or coffee pots when units are stacked on a riser.
- Each unit includes a set of beverage label.
- Interlocking construction allows for stable stacking and space saving.



Vent caps
Balanced pressure makes the container easily open.



Recessed faucet
Accommodates for larger cups,
Two positions, one for continuous pouring.
And the other for individual dispensing.



1 inch ultra latch
With durable plastic ultra latch. It won't rust.
Suitable for JW-INC7L, JW-INC9.4L
JW-INC18L.



9.5 inch ultra latch
Wide nylon latches are rust free and easy to
open and close by one hand
Suitable for JW-INC44.5L.

Insulation Effect

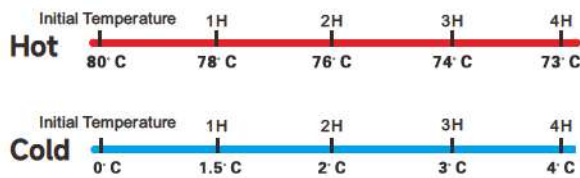

| Art.No. | JW-INC7L | JW-INC9.4L | JW-INC18L | JW-INC44.5L |
|----------|---------------------------|-----------------------------|----------------------------|------------------------------|
| Name | 7L Insulated Drink Server | 9.4L Insulated Drink Server | 18L Insulated Drink Server | 44.5L Insulated Drink Server |
| Size | 420x230x420 mm | 420x230x470 mm | 420x230x620 mm | 530x415x630 mm |
| Spigot | YES | YES | YES | YES |
| Capacity | 7L | 9.4L | 18L | 44.5L |
| Material | PU/PE | PU/PE | PU/PE | PU/PE |
| Colour | Brown | Brown | Brown | Brown |
| PCS/CTN | 1 | 1 | 1 | 1 |

Insulated Food Servers



Insulated Food Servers

- It can hold food pans in sizes of 1/1, 1/2. With seamless PE construction, thick foam material, tenacious padlock and a dismantlable airtight gasket, it can preserve food heated for several hours without external power supply.
- A vent cap can balance pressure and help easy opening.
- Non-slip handles make it easier to be carried.
- A durable nylon latch will never get rust.



Insulation Effect



Accessories Available



| | |
|----------|----------------|
| Art.No. | JW-FOC |
| Name | Ultra Carts |
| Size | 530x710x230 mm |
| Material | PE/PU |
| Colour | Grey |
| PCS/CTN | 1 |

Note:JW-FOC Suitable for JW-SIF



| Art.No. | JW-SIF | JW-DOW |
|--------------------|-----------------------|-------------------------|
| Name | Insulated Pan Carrier | Double For Food Carries |
| Outer Size | 477x680x620 mm | 508x700x1200 mm |
| Inter Size | 335x533x495 mm | 335x533x420 mm(Double) |
| GN1/1 Height 6.5cm | 6PCS | 10PCS |
| GN1/1 Height 10cm | 4PCS | 6PCS |
| GN1/1 Height 15cm | 3PCS | 4PCS |
| GN1/1 Height 20cm | 2PCS | 4PCS |
| Material | PE/PU | PE/PU |
| Colour | Grey | Grey |
| PCS/CTN | 1 | 1 |

Insulated Food Servers

Premium Series Insulated Pan Carrier



- It can hold food pans in sizes of 1/1, 1/2. With seamless PP construction, thick foam material, tenacious padlock and a dismantlable airtight gasket, it can preserve food heated for several hours without external power supply.
- Make a number of cold and hot food food plate warm for several hours.
- Strong and durable **PP shell with thick PU insulation material.**

Labeling area
For adhering vital routing and content information

Easy to clean
Door is removable for easy cleaning

Ergonomic design
Anti-resistant, ergonomically designed inner cast handles provide comfortable handling operations.

Top support design
Put the 1 / 1 GN pans on the carriers to make the meal service more convenient

Take quickly and close the button
Nylon button handle, durable and no rust

Sealing design, no gasket

Keep temperature
The 35mm thick PU insulation material can ensure the appropriate temperature of the cold and hot food.

Pressure control
Door with air holes, Can balance the pressure

Insulation Effect

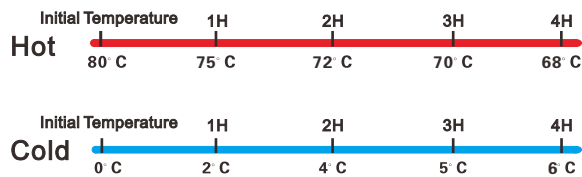

| | |
|--------------------|-----------------------|
| Art.No. | JW-IPC |
| Name | Insulated Pan Carrier |
| Outer Size | 477x680x620 mm |
| Inter Size | 335x533x495 mm |
| GN1/1 Height 6.5cm | 6PCS |
| GN1/1 Height 10cm | 4PCS |
| GN1/1 Height 15cm | 3PCS |
| GN1/1 Height 20cm | 2PCS |
| PCS/CTN | 1 |



Insulated Food Servers

Electric Heating Food Pan Carriers

- Designed for both electric hot holding and non-electric transport.
- Holds a wide variety of foods such as pasta, bone-in fried chicken, and double-crusteds pies.
- Energy consumption is substantially less than comparable metal cabinets.
- Will not rust or dent like metal cabinets, is more economical, and is easy to maneuver.
- Hot food temperatures, for up to 4 hours when unplugged.



12-hour Temperature Chart

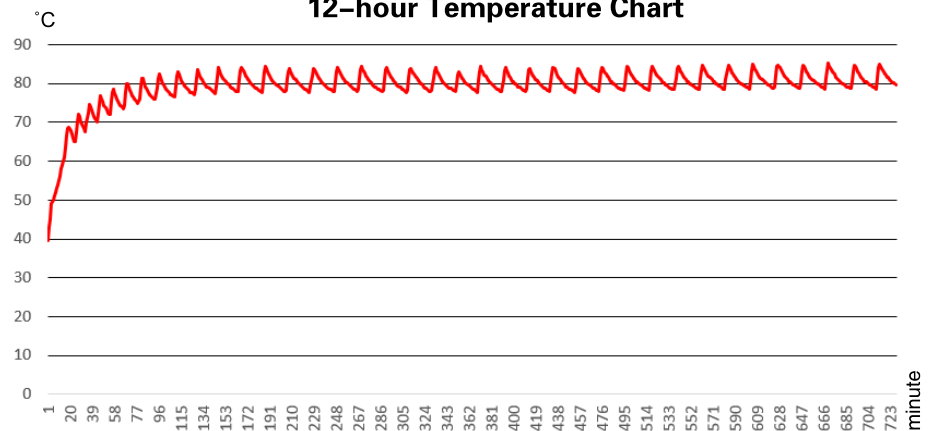

| | |
|------------|------------------------------------|
| Art.No. | JW-EPC |
| Name | Electric Heating Food Pan Carriers |
| Outer Size | 477x680x620 mm |
| Inter Size | 335x533x495 mm |
| Material | PE/PU |
| Colour | Grey |
| PCS/CTN | 1 |

Electric Heating Food Pan Carrier Placement Effect diagram

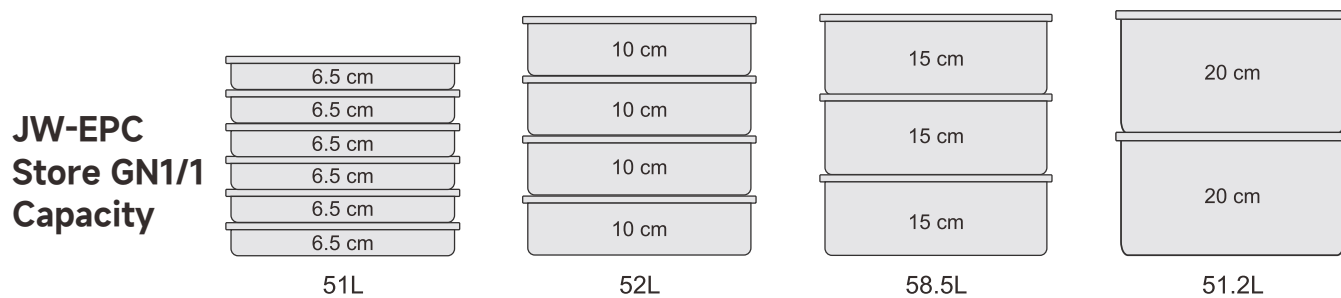

Insulated Pan / Sliding Ice Caddy



Insulated Pan

- Used to store and transport hot or cold food.
- Thick foam material can preserve food heat for several hours without external power supply.
- A vent cap can balance pressure and help easy opening.
- Boxes can be interlocked and stacked up for better transporting and for saving space.
- Boxes can be taken out through notches.
- Easy to be cleaned up.



Insulation Effect

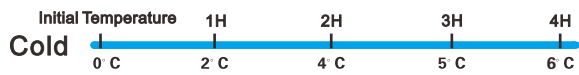

| Art.No. | JW-INF100H | JW-INF150H | JW-INF200H |
|----------------------|-----------------------|-----------------------|-----------------------|
| Name | Insulated Pan Carrier | Insulated Pan Carrier | Insulated Pan Carrier |
| Outer Size | 630x440x210 mm | 630x440x260 mm | 630x440x305 mm |
| Compartment Capacity | 1 GN1/1-100mm | 1 GN1/1-150mm | 1 GN1/1-200mm |
| | 2 GN1/2-100mm | 2 GN1/2-150mm | 2 GN1/2-200mm |
| Accompany With Carts | JW-FOC | JW-FOC | JW-FOC |
| Material | PE/PU | PE/PU | PE/PU |
| Colour | Grey | Grey | Grey |
| PCS/CTN | 1 | 1 | 1 |



Sliding Ice Caddy

- The caddy stores ices and keeps ices from melting.
- Thick foam construction helps better preservation.
- The sliding lid helps to reduce cross contamination.
- The water tank and a drain shelf separate water and ices, prolonging storage time.
- The ergonomically designed handles make transporting easy.
- Installation is needed.



| | |
|----------------------|-------------------|
| Art.No. | JW-SLI |
| Name | Sliding Ice Caddy |
| Outer Size | 585x800x745 mm |
| Capacity | 110L |
| Weight Capacity(ice) | 57KG |
| Material | PE/PU |
| Colour | Grey |
| PCS/CTN | 1 |

EPP Insulated Pan Carrier

EPP Insulated Pan Carrier

- It can hold more than GN1/1 pan.
- Made of **EPP material**, sturdy, light and durable
- Great structural strenght, capable of handling significant loads while maintaining its shape and form.
- With good insulation and heat resistance, it can withstand temperature from -40°C to +120°C.
- Ideal to store hot and cold food safely for hours
- Clean, sealed, 100% recyclable.

Insulation Effect

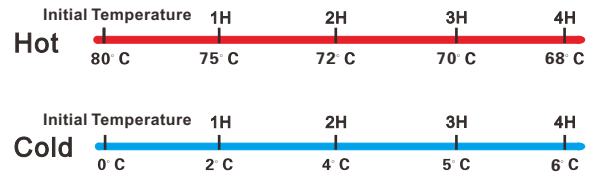

-40°C to 120°C



| Art.No. | JW-CD2516 | JW-EPP160 | JW-EPP180 | JW-EPP400 |
|------------|--------------------------------|-------------------|-------------------|------------------------------|
| Name | EPP Insulated Pan Carrier Cart | EPP160 Top Loader | EPP180 Top Loader | EPP400 Insulated Pan Carrier |
| Outer Size | 647x427x205 mm | 600x400x260 mm | 600x400x317 mm | 640x435x630 mm |
| Inter Size | / | 535x335x195 mm | 535x335x252 mm | 535x335x525 mm |
| Colour | Black+Silver | Black | Black | Black |
| PCS/CTN | 1 | 1 | 1 | 1 |

EPP Insulated Pan Carrier

Insulated Pan Carrier Placement Effect Diagram

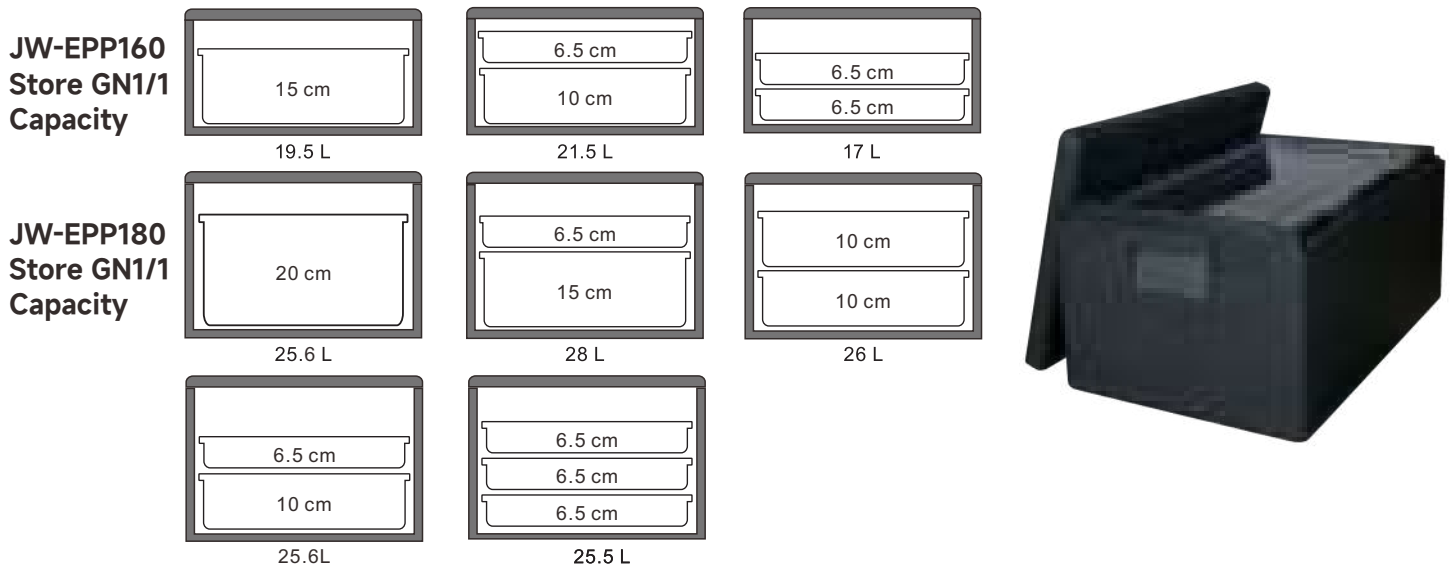

Insulated Pan Carrier Placement Effect Diagram

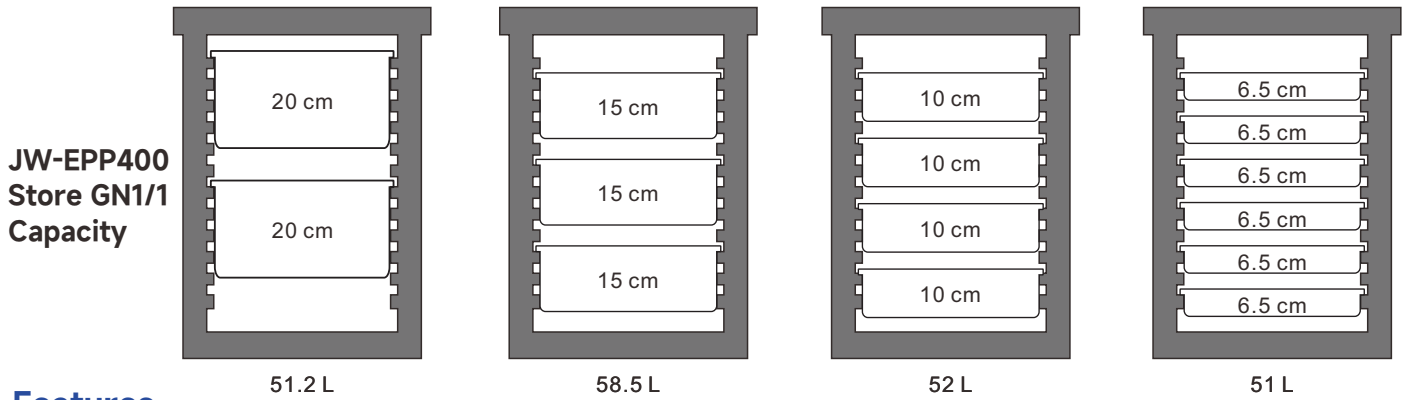

Features

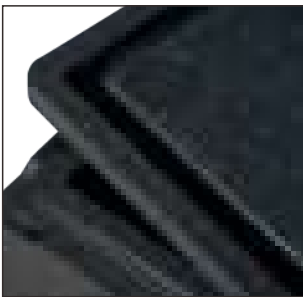

Sealing slot design helps to maintain temperature for a longer time.



Can be stacked easily



Can store GN1/1 PAN



Inside label area for label placing



The built-in handle is convenient for grasping from four sides and easy to handle.



With guide track design, can hold 2-6pcs 1/1 GN pans



Declining edge helps easy door opening and closing



270°Open door

EPP Insulated Pan Carrier

Cooling and Warming Food Box

- Constant temperature heating distribution and constant motion low temperature distribution.
- Make different foods achieve the best safe and hygienic environment for storage.
- The compartment design can meet the requirements of both hot and cold placement.
- Made of EPP material, sturdy, light and durable



| | |
|-------------------|------------------------------|
| Art.No. | JW-EPP170E |
| Name | Cooling and Warming Food Box |
| Outer Size | 600x403x376 mm |
| Capacity | Freezer19L / Incubator32L |
| Colour | Black |
| PCS/CTN | 1 |

At 20°C environment, cooling and warming tests results are shown as below:

Four-hour temperature chart

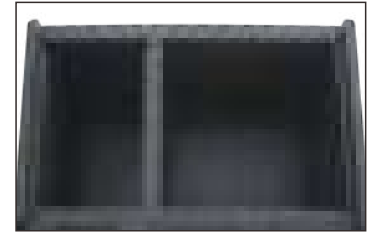
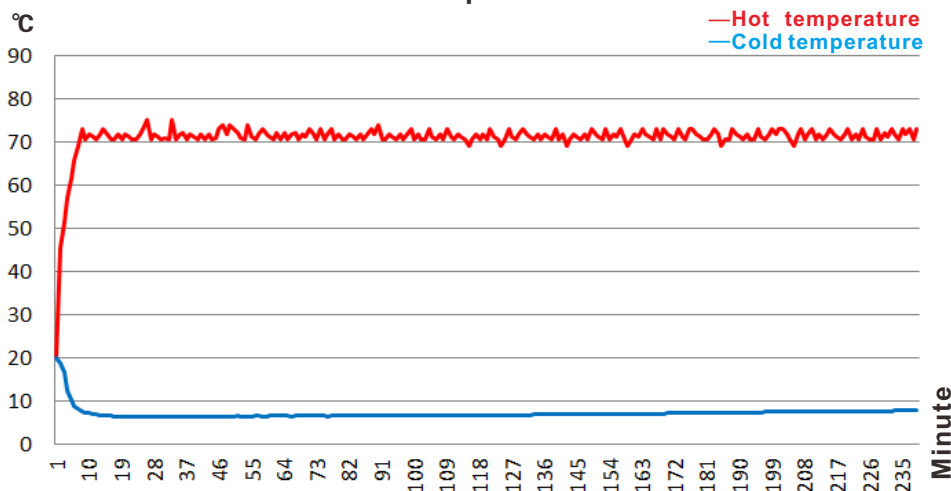

Grid design
Can meet the needs of hot and cold placement at the same time.



Ice core
Maintain the cooling condition for a long time.



VIP separator layer
Lower interaction between hot and cold spaces.

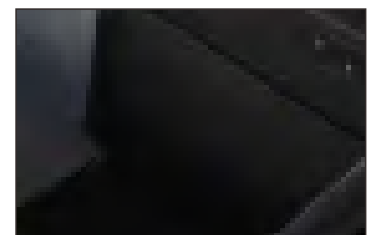

Carbon fiber heating core
Keep the temperature inside the box above 60°C.



Power Adapter China standard
INPUT:100-240V-50/60Hz 2.5A
OUTPUT:12V - 10A





Insulated Transport Series

Mobile Plate Rack

Plate Rack For 12/48 Plates

- 48/84 plate mobile plate rack and 12/48-plate floor-standing plate rack are the most innovative, the most widely used plate rack at present.
- Can hold trays, dishes and flat plates.
- Can be adjusted to any size.
- Separating columns and rubber granules are made of soft copolymer resin, and this can protect plates from breaking.
- The separated design provides strong support and stability.
- 4" non-trace casters with brake of 48/84-plate rack are non-slip and resistant to oil and water, standing with higher stability and security.
- The rubber bottom granules of 12/48- plate rack can stick to the floor, standing more stably.
- With strict sanitary inspection, all materials are environmental-friendly, durable and will do no harm.



| Art.No. | JW-DC12B | JW-DC48B |
|------------|--------------------------|--------------------------|
| Name | Plate Rack For 12 Plates | Plate Rack For 48 Plates |
| Outer Size | 350x350x460 mm | 545x545x1080 mm |
| Axis Width | 245 mm | 245 mm |
| Max Width | 350 mm | 560 mm |
| PCS/CTN | 1 | 1 |

Mobile Plate Rack

- Can be used to store 40/80 plates.
- Can easily move plates soonest to storage or banquet areas.
- High-quality swivel caster care for stability.
- Save space and efficient working.

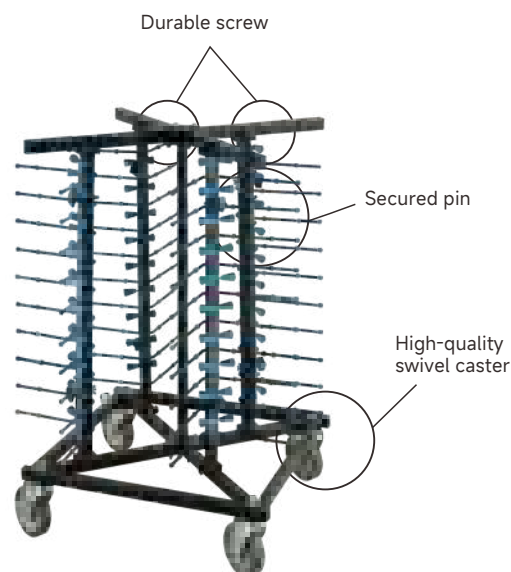

Vinyl Cover included for sanitary storage.



| Art.No. | JW-DC48 | JW-DC84 | JW-DC40 | JW-DC80 |
|-------------|---------------------------------|---------------------------------|---------------------------------|---------------------------------|
| Name | Mobile Plate Rack For 48 Plates | Mobile Plate Rack For 84 Plates | Mobile Plate Rack For 40 Plates | Mobile Plate Rack For 80 Plates |
| Outer Size | 730x730x1260 mm | 730x730x1910 mm | 575x575x1003 mm | 575x575x1790 mm |
| Axis Width | 245 mm | 245 mm | 790 mm | 790 mm |
| Max Width | 600 mm | 675 mm | 575 mm | 575 mm |
| Vinyl Cover | JW-VC48 | JW-VC84 | JW-VC40 | JW-VC80 |
| PCS/CTN | 1 | 1 | 1 | 1 |

Note: Vinyl cover needs to buy separately.

Adjustable Dish Caddy

Adjustable Dish Caddy

- Store one size dish or a combination of different sizes in a single caddy.
- The dividers are adjustable.
- Streamlined design, PP dividing columns can prevent damages.
- Arcuate corners can protect using place from damages.

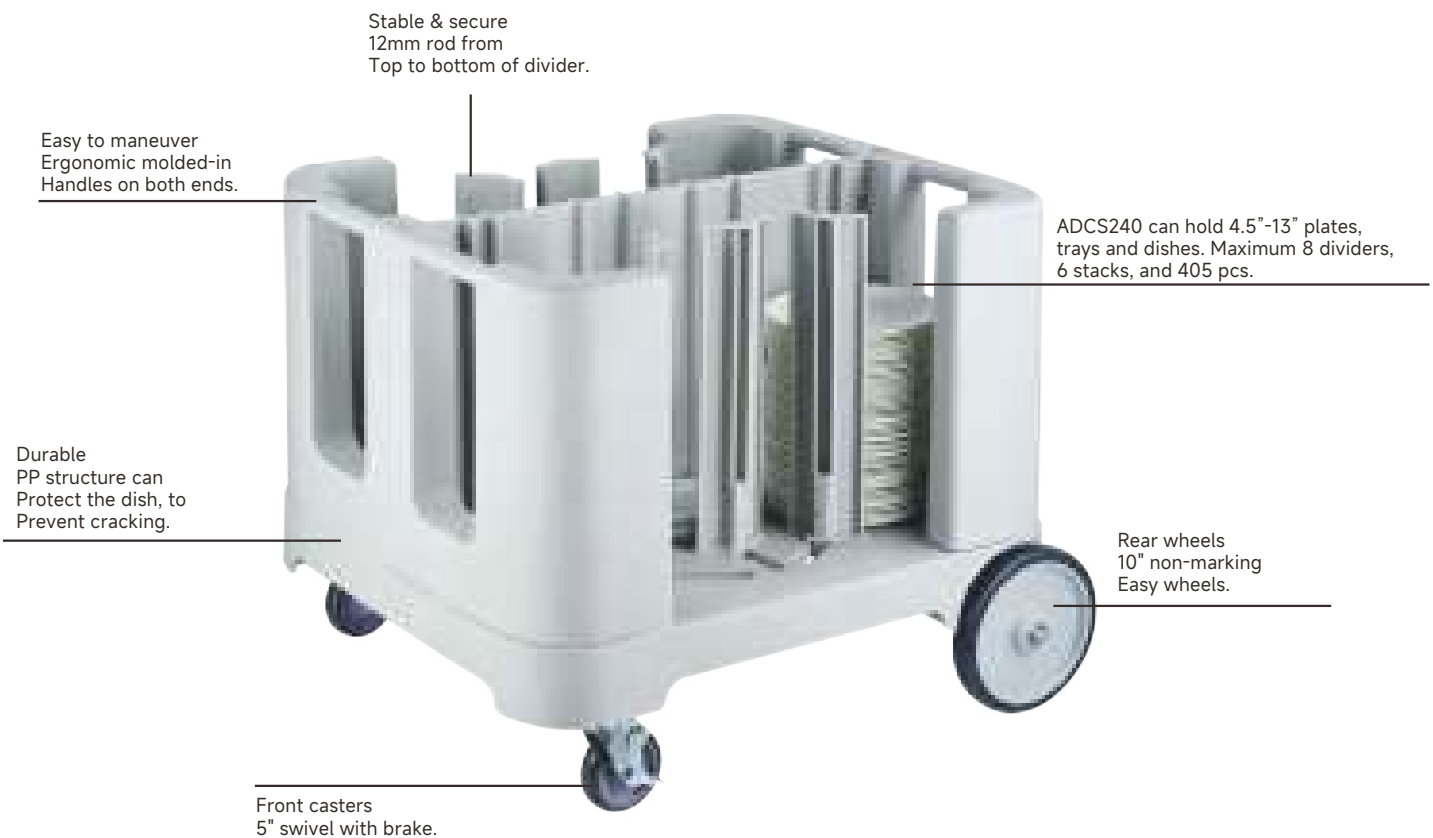
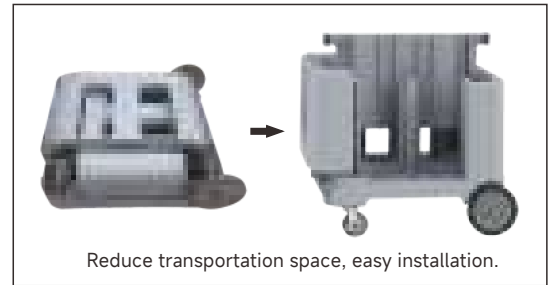

| | |
|----------|-----------------------|
| Art.No. | JW-ADCS240 |
| Name | Adjustable Dish Caddy |
| Size | 963x908x763mm |
| Material | PP |
| Colour | Grey |
| PCS/CTN | 1 |

Adjustable Dish Caddy

Adjustable Dish Caddy

- Streamlined design, PE dividing columns can prevent damages.
- Arcuate corners can protect using place from damages.
- Non-slip handles make easy moving.
- The dividers are adjustable.



Vinyl cover included for sanitary storage.



JW-DC160

DC160 can hold 4.5"-13" plates, trays and dishes. Maximum 4 dividers, 4 stacks, and 200 pcs.



JW-DC320

DC320 can hold 4.5"-13" plates, trays and dishes. Maximum 6 dividers, 8 stacks, and 400 pcs.

| Art.No. | JW-DC160 | JW-DC320 |
|----------|-----------------------|-----------------------|
| Name | Adjustable Dish Caddy | Adjustable Dish Caddy |
| Size | 900x725x800 mm | 1090x720x800 mm |
| Material | PE | PE |
| Colour | Brown | Brown |
| PCS/CTN | 1 | 1 |

Adjustable Dish Caddy

JW-DC320



DC320 Layout for 10" by 14-1/2" trays and 7-1/2" to 10" plates

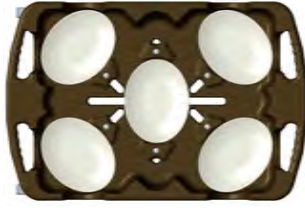

DC320 Layout for 12" by 9-1/4" and 9-1/2" by 7-1/4" plates

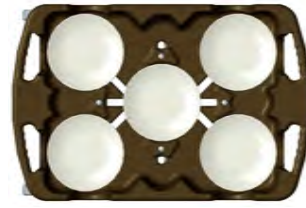

DC320 Layout for 9-4/5" to 11-1/4" plates

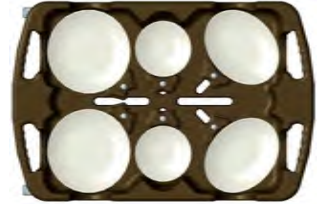

DC320 Layout for 12" by 9" to 9-1/2" by 7-1/4" plates. 4-1/2" to 8" plates and 5-1/2" to 12" plates"



DC320 Layout for 8" to 8-1/4" plates

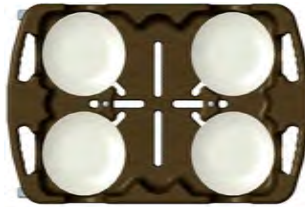

DC320 Layout for 11-2/5" to 13" plates and 13-1/2" by 10-1/2" plates

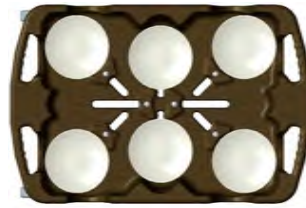

DC320 Layout for 8-2/5" to 8-4/5" plates

JW-DC160



DC160 layout for 6" to 13" plates



DC160 layout for 4-1/2" to 6" plates

JW-ADCS240

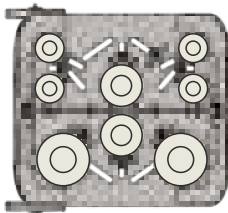

Layout for 7" by 9" trays
4.5" and 5.5" to 7" plates

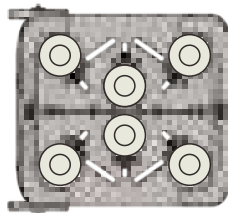

Layout for 5.5" to 7" plates

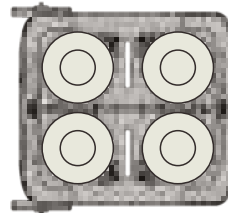

Layout for 9" to 13" plates

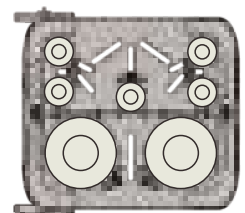

Layout for 9" to 13" plates
and 5" plates

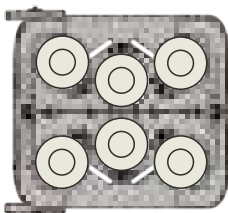

Layout for 7" to 9" plates

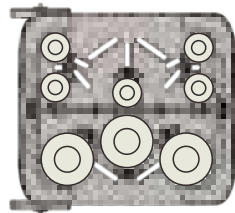

Layout for 7" to 9"
plates and 4.5" plates

Wall Mount Plate Rack

Wall Mount Plate Rack

- Flexible usage, lower labor cost, fast delivery, efficient work.
- Separating columns and rubber granules are made of soft copolymer resin, and this can protect plates from breaking and collapsing.
- The separated design provides much more support and stability.
- Holds 6-21 plates.
- Take dinner plates off counter.



| Art.No. | JW-WM21 | JW-WM18 | JW-WM12 | JW-WM9 | JW-WM6 |
|----------------------|-------------------------------------|-------------------------------------|-------------------------------------|------------------------------------|------------------------------------|
| Name | Wall Mount Plate Rack For 21 Plates | Wall Mount Plate Rack For 18 Plates | Wall Mount Plate Rack For 12 Plates | Wall Mount Plate Rack For 9 Plates | Wall Mount Plate Rack For 6 Plates |
| Outer Size | 120x100x1625 mm | 120x100x1425 mm | 120x100x1015 mm | 120x100x810 mm | 120x100x575 mm |
| Hold Plates Quantity | 21 PCS | 18 PCS | 12 PCS | 9 PCS | 6 PCS |
| PCS/CTN | 1 | 1 | 1 | 1 | 1 |

26 Sheet Pan Rack

26 Sheet Pan Rack

- Sideboards can fix food pans.
- Ergonomically designed handle can be easily controlled with safety.
- The top and the bottom are made from plastics of industrial hardness.
- Easy to clean up. The sideboards are made of chromium alloy, anti-collision and anti-corrosion.
- Protective anti-collision devices can reduce scratches and collisions.
- It can support food pans in size of 18" x 26"
- Bearing Capacity: 150KG



JW-PRC

| Art.No. | JW-PR26 | JW-PRC | JW-PR261B |
|-----------------|-------------------|--------------------------|---------------|
| Name | 26 Sheet Pan Rack | Cover For Sheet Pan Rack | Pan |
| Size | 758x585x1750 mm | 700x590x1550 mm | 660x460x30 mm |
| Weight Capacity | 130 kg | / | 1.32 kg |
| Colour | Black | Clear | Black |
| Material | S/S/Chrome/PP | PVC | Aluminum |
| PCS/CTN | 1 | 1 | 10 |

Tray Table Ware Cart

Tray Table Ware Cart

- Designed to carry trays.
- Trays and accessories can be put inside the cart .
- Eight compartments on the top can place food pans to store tablewares, napkins and bagged seasonings.

| | |
|-------------------|----------------------------|
| Art.No. | JW-TRT |
| Name | Tray Table Ware Cart |
| Size | 820x540x1160 mm |
| Weight Capacity | 100 kg |
| Tray Capacity | 180-200PCS (In two stacks) |
| Maximum Tray Size | 360x460 mm |
| Material | PE/PU |
| Colour | Grey |
| PCS/CTN | 1 |

Food Pan Quantity

| Food Pan Quantity / Size | Capacity |
|--------------------------|--|
| 4 GN1/3 x 10 CM Height | It contains 100 knives, 100 spoons and 80 forks. |
| 4 GN1/6 x 10 CM Height | It can accommodate various bags of seasoning. |



Multiduty Service Cart

Multiduty Service Cart

- Light and flexible, ideal for hotels, restaurants and bars.
- Can be used to collect and carry food or table wares in room service.
- PP material is environmental, sanitary, durable and easy to be cleaned.
- Three-tier design provides enough space for storage.
- Bear capacity: 120 KG
- With more convenient open top layer.
- Ergonomically designed handle can be comfortably and flexibly used.
- Optional with half open and full open.



| Art.No. | JW-SED | JW-SEDO | JW-SSC |
|------------|------------------------|-----------------------------|-----------------------------------|
| Name | Multiduty Service Cart | Open Multiduty Service Cart | Small Open Multiduty Service Cart |
| Outer Size | 980x530x930 mm | 980x530x930 mm | 800x420x950 mm |
| Comp.Size | 800x530x300 mm | 800x530x300 mm | 610x390x310 mm |
| Colour | Black | Black | Black |
| Bear | 120 kg | 120 kg | 100 kg |
| Material | PP | PP | PP |
| PCS/CTN | 1 | 1 | 1 |



| Art.No. | JW-PSC14 | JW-PSC19 | JW-PSC22 | JW-PSC26 | JW-SH9 | JW-TC30 |
|----------|-----------------|-----------------|-----------------|-----------------|------------------|----------------|
| Name | 14L Debris Disc | 19L Debris Disc | 22L Debris Disc | 26L Debris Disc | 9L Tableware Box | 30L Trash Can |
| Size | 530x379x126 mm | 574x424x122 mm | 555x390x190 mm | 545x431x176 mm | 330x230x178 mm | 330x230x560 mm |
| Capacity | 14L | 19.2L | 22.6L | 26.2L | 9L | 30L |
| Weight | 830g | 1100g | 1235g | 1459g | 620g | 1535g |
| Material | PP | PP | PP | PP | PP | PP |
| PCS/CTN | 12 | 12 | 12 | 12 | 6 | 6 |

Collapsible Laundry Cart

Collapsible Laundry Cart

- Compact, light, and collapsible. It enable efficient storage.
- With large capacity, durable and reusable.
- Detachable, easy to clean up.
- Black lacquer covers up stains and dirt.
- High-quality TPR casters move quietly.
- Synthetic rubber straps help to prevent damage.



Solid material and excellent spraying process make no warp or rust.



JW-XC150



Swivel casters are with superior maneuverability, meanwhile, synthetic rubber straps can provide additional protection while moving.



Compact, collapsible frame reduces width by 75% to enable efficient storage.



JW-XC300M



JW-XC300

Sheets, clothes or garbage can be collected with two 150L high capacity vinyl bags. Sorted collection saves costs and improves efficiency.

| Art.No. | JW-XC150 | JW-XC300 | JW-XC300M | JW-RB150 | JW-RB300 |
|-------------|-------------------------------------|-------------------------------------|---|------------------------------|------------------------------|
| Name | 150L Collapsible Laundry Cart | 300L Collapsible Laundry Cart | 300L Mult-stream Collapsible Laundry Cart | 150L High-Capacity Vinyl Bag | 300L High-Capacity Vinyl Bag |
| Description | With a 150L high-capacity vinyl bag | With a 300L high-capacity vinyl bag | With two 150L high-capacity vinyl bag | / | / |
| Size | 660x495x860 mm | 895x660x860 mm | 895x660x860 mm | 355x560x750 mm | 730x560x750 mm |
| Capacity | 150L | 300L | 300L | 150L | 300L |
| Colour | Black | Black | Black | Black | Black |
| Material | Powder Coated | Powder Coated | Powder Coated | Vinyl | Vinyl |
| PCS/CTN | 1 | 1 | 1 | 1 | 1 |

Cube Trucks

Cube Trucks

- Integrated molding design, smooth surface, easy to clean;
- It can be used in various use scenarios such as linen transportation, material collection and cargo transportation;
- Two multidirectional wheels, and two directional wheels
- The requirement for in-situ rotation can be achieved



Industrial strength
Heavy transportation
is easy.

Rotational moulding
Integrated molding design



Flexible operation
Two multidirectional wheels, and two
directional wheels.
The requirement for in-situ rotation
can be achieved

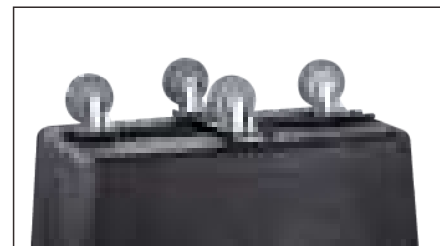

Metal chassis at the bottom

| | |
|----------|----------------------------|
| Art.No. | JW-CT12 |
| Name | Cube Trucks |
| Size | 1070x740x860 mm |
| Colour | Black |
| Bear | 180KG |
| Capacity | 12 Cubic Foot / 9.6 Bushel |
| Material | PE |
| PCS/CTN | 1 |

Casters

| | | |
|---------|---------------------------------|------------------------|
| Art.No. | JW-IPSW | JW-IPSC |
| Name | 5" Universal Casters With Brake | 5" Directional Casters |
| Size | 5" | 5" |
| Colour | Grey | Grey |

Folding Cart

Folding Cart

- Widely used in all kinds of restaurants and hotels.
- Thick stainless steel material structure, frosted surface, beautiful and durable.
- Buckle design, faster and simply folding or unfolding the cart.
- Folding storage can reduce the area of 50%.
- Ergonomic handle design, comfortable operation.
- 4" universal silent wheels, of which two with brakes;
- Safe and quiet.
- Bear capacity: 150KG.



Easily holds with one hand!



| | | |
|---------|--------------------|------------------|
| Art.No. | JW-FC2115 | JW-FC3021 |
| Name | Small Folding Cart | Big Folding Cart |
| Size | 420x740x900 mm | 520x990x900 mm |
| Colour | Black | Black |
| Weight | 13.1 kg | 17.6 kg |
| PCS/CTN | 1 | 1 |

Heavy-duty Platform Trucks

Heavy-duty Platform Trucks

- Unique Mute. transmission design makes it move silently and smoothly.
- It's novel and beautiful. Strips added on surface can effectively avoid sliding.
- It's suitable for hotel & restaurant transport, and other transport of goods.
- Foldable handle.
- Bear 300KG.

| | |
|---------|----------------------------|
| Art.No. | JW-HD3624 |
| Name | Heavy-duty Platform Trucks |
| Size | 903x605x860 mm |
| Colour | Grey |
| Weight | 16.0 kg |
| PCS/CTN | 1 |



Heavy-Duty Utility Cart

Heavy-Duty Utility Cart

- Supplies and heavy loads can be carried safely out in most environments.
- Flapse platform or flush platform.
- The ergonomically designed grip height is more comfortable for use, improving handling and worker safety.



JW-HD3416



JW-HD4025



JW-HD4324



JW-HDF4425

| Art.No. | JW-HD3416 | JW-HD4025 | JW-HD4324 | JW-HDF4425 |
|---------|-------------------------------|-------------------------|-------------------------------------|---------------------------------------|
| Name | Small Heavy-Duty Utility Cart | Heavy-Duty Utility Cart | Heavy-Duty Utility Cart With Handle | Platform Type Heavy-Duty Utility Cart |
| Size | 87.5x42.5x82.7 cm | 101.5x62.5x82.7 cm | 109.5x62.5x97 cm | 102x64x82 cm |
| Colour | Black | Black | Black | Black |
| Bear | 250 kg | 250 kg | 227 kg | 250 kg |
| PCS/CTN | 1 | 1 | 1 | 1 |



Dinner Chair

Dinner Chair

- The design has taken a full consideration of the capacity and stability.
- The matched tray can be used conveniently. It can be taken down with one hand. Two colors are optional. Black and Grey are available.
- Stackable design makes for easy storage.

Meets the ASTM F404-16 safety standards



JW-D1



Stackable Design



Patent No.: 201020026959.X

| Art.No. | JW-D1 | JW-DA |
|-----------------|---------------|----------------|
| Name | Tray | Dinner Chair |
| Size | 367x476x72 mm | 590x640x740 mm |
| Weight Capacity | / | 60 kg |
| Colour | Grey | Grey |
| Material | PP | PP |
| PCS/CTN | 1 | 1 |

Baby Chair

- The curve shape seat can keep the child sit comfortably.

| Art.No. | JW-B |
|---------------|----------------|
| Name | Baby Chair |
| Size | 316x311x238 mm |
| Inside Seat A | 210x244x90 mm |
| Inside Seat B | 273x273x120 mm |
| Colour | Black/Coffee |
| Material | PE |
| PCS/CTN | 1 |



ASTM F2640-18 Compliant

Baby Changing Stations

- PP material Safety and health
- Hydraulic rod design folds, opens and closes gently
- Storage box design multi-functional storage
- Safety belt design avoid accidental falling

| Art.No. | JW-BCS |
|-------------|------------------------|
| Name | Baby Changing Stations |
| Open state | 870x550x500 mm |
| Close state | 870x550x110 mm |
| Colour | Grey |
| Material | PP |
| PCS/CTN | 1 |



Closed state



Open state



Compact Cleaning Cart

Compact Cleaning Cart

- Aesthetically designed suitable to be used in the lobby.
- Innovative model tool grips can hold cleaning tools.
- With novel design, excellent efficiency and beautiful shape, it can be used to clean & collect light garbage.
- Compact design helps for easier operation and better observation.
- Advanced bidirectional opening lids help to increase working efficiency.



Optional with a 32-gallon recycle round container (JW-CR120E)



Optional with two 20-gallon recycle containers (JW-CR76S)



Storage platform for mop bucket



Simplified Compact Cleaning Cart (JW-CCSS)

| Art.No. | Name | Description | Size | Weight | PCS/CTN |
|---------|----------------------------------|---|-----------------|---------|---------|
| JW-CCS | Compact Cleaning Cart | Equipped with 19 gal of recycling bag(bk) Equipped with 9 gal of storage cabinet Equipped with a 10 QT disinfection-pail(JW-DP10) | 1260x575x975 mm | 15.8 kg | 1 |
| JW-CCSS | Simplified Compact Cleaning Cart | Equipped with 19 gal of recycling bag(bk) Equipped with a 10 QT disinfection-pail(JW-DP10) | 1095x575x975 mm | 12.8 kg | 1 |

Cleaning Cart Series

Luxury Compact Cleaning Cart

-Two recyclable bags make it easier to collect and sort garbage.



Optional with a 20-gallon Recyclable container (JW-CR76S)



Simplified Luxury Compact Cleaning Cart (JW-CCLS)



JW-CCL

| Art.No. | Name | Description | Size | Weight | PCS/CTN |
|---------|---|---|-----------------|---------|---------|
| JW-CCL | Luxury Compact Cleaning Cart | Equipped with two 19 gal of recycling bags (BK) Equipped with one 9 gal cabinet Equipped with one 10 quart disinfection pail(JW-DP10) | 1260x575x975 mm | 19.3 kg | 1 |
| JW-CCLS | Simplified Luxury Compact Cleaning Cart | Equipped with two 19 gal of recycling bags (BK) Equipped with one 10 quart disinfection pail(JW-DP10) | 1095x575x975 mm | 15.0 kg | 1 |

Multifunctional Cleaning Cart

Made of rustless aluminum and solid plastic. With a non-slip and comfortable handle, two 4" swivle and two 8" directional casters. Easy to clean up.

- Storage platform for mop bucket.
- Collapsible platform for disinfection pail.
- Innovative rubber tool grips hold handles at any position.
- Optional with two 30-quart storage barrels that can be installed on both sides of the cart(JW-SB30).



JW-CCMD

| Art.No. | Name | Description | Size | Weight | PCS/CTN |
|---------|-------------------------------|---|------------------|---------|---------|
| JW-CCMD | Multifunctional Cleaning Cart | Equipped with a 30 gal high-capacity vinyl bag.(YL) Equipped with two 10-quart disinfection pails. (JW-DP10) | 1212x575x1115 mm | 19.8 kg | 1 |

Cleaning Cart Series

High Capacity Cleaning Cart

- With high capacity, flexible. It's a one-stop and tidy tools.-
- Optional with two 30-quart storage barrels that can be installed on both sides of the cart(JW-SB30).
- Optional with 20 gallons waste container(JW-CR76S).

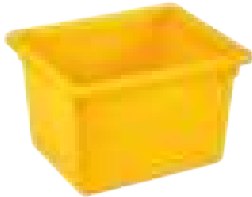

JW-SB30



| Art.No. | Name | Description | Size | Weight | PCS/CTN |
|---------|-----------------------------|---|------------------|---------|---------|
| JW-CCHD | High Capacity Cleaning Cart | Equipped with two 30 gal high-capacity vinyl bags.(YL) Equipped with two 10-quart disinfection pails.(JW-DP10) | 1300x575x1115 mm | 21.1 kg | 1 |

Triple Capacity Cleaning Cart

Triple capacity cleaning cart provides multi-stream collection for efficient, cost-effective sorting.

- Rubber tool grips hold handles upright.
- Non-rusting and easy-to-clean aluminum and structural web plastic construction.
- With two 4" swivel casters and two stable 8" directional casters

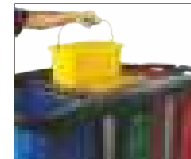

Optional with two 10-quart disinfection pails



With two 8" silent casters



Optional with three 30-quart yellow vinyl bags



Optional with three 30-quart black vinyl bags



| Art.No. | Name | Description | Size | Weight | PCS/CTN |
|---------|-------------------------------|--|------------------|---------|---------|
| JW-CCTD | Triple Capacity Cleaning Cart | Equipped with three 30 gal high-capacity vinyl bags.(RD/GN/BU) | 1300x575x1115 mm | 19.1 kg | 1 |

Innovative Cleaning Cart

- Fully meet the requirement of micro fiber cleaning.
- Tools can be stored in innovative rubber holders on both sides at any position of handles.
- Optional with two 30-quart storage barrels that can be installed on both sides of the cart(JW-SB30).
- Optional with 20 gal recycling containers(JW-CR76S).

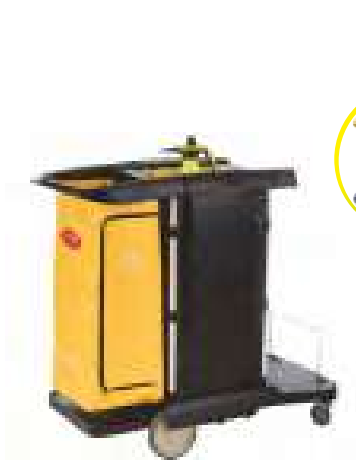
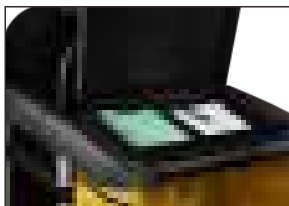

Platform for storing mobile mop buckets. (JW-MP32)



Optional with two 30-quart storage barrels(JW-SB30).

| Art.No. | Name | Description | Size | Weight | PCS/CTN |
|---------|--------------------------|--|------------------|---------|---------|
| JW-CCID | Innovative Cleaning Cart | Equipped with two 10-quart disinfection pails. (JW-DP10) Two doors with lock.(on both sides of the cart) Equipped with a 30 gal high-capacity vinyl bag.(YL) | 1212x575x1115 mm | 29.1 kg | 1 |

Cleaning Cart Series

Luxury Cleaning Cart

- Fully meet the requirement of micro fiber cleaning.
- Rubber tool grips in front and back.
- Optional with two 30-quart storage barrels that can be installed on both sides of the cart.(JW-SB30)
- Optional with two 10-quart disinfection pails, each one can carry 6 sprayers.(JW-DP10)
- Optional with 20 gallon recycling containers.(JW-CR76S)
- Locking cabinet doors. Locking security hood and waster cover.



A retractable handle can save space



Platform for storage mobile mop buckets



| Art.No. | Name | Description | Size | Weight | PCS/CTN |
|---------|----------------------|--|------------------|---------|---------|
| JW-CCED | Luxury Cleaning Cart | Two doors with lock (On both sides of the cart) Equipped with a storage box and a security cover with lock Equipped with a 30 gallons high-capacity vinyl bags | 1212x575x1320 mm | 33.6 kg | 1 |

Medical Places Special Cleaning Cart

Match the requirement of Joint Commission on Accreditation of Healthcare Organizations (JACHO); Standard storage cabinet with lock, security cover with lock and a storage box.

- With Locking, cabinet doors.
- Platform for storing mobile mop buckets.
- Collapsible platform for disinfection pails.
- Optional with 20 gallon recycling container.
- Tools can be stored in innovative rubber holders on both sides at any position of the handles.



| Art.No. | Name | Description | Size | Weight | PCS/CTN |
|---------|--------------------------------------|---|------------------|---------|---------|
| JW-CCMS | Medical Places Special Cleaning Cart | Two doors with lock. (On both sides of the cart) Equipped with two storage boxes and a security cover with lock. Equipped with two 30 gallons high-capacity vinyl bags.(YL) | 1300x575x1320 mm | 35.7 kg | 1 |

Accessories

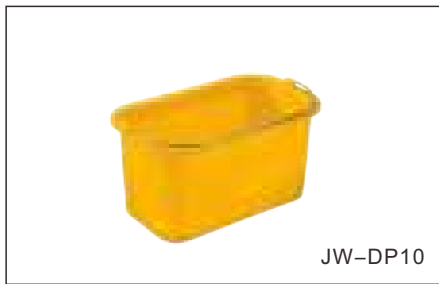

JW-DP10



JW-SB30

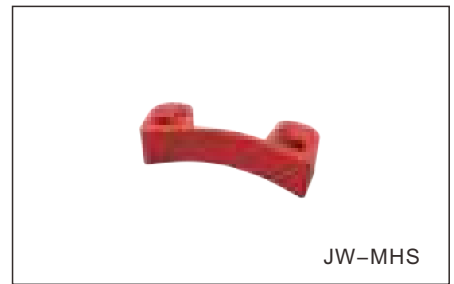

JW-MHS



JW-MP32



JW-CR76S



JW-CR120E



JW-FS



JW-CCDL



JW-CCCB



JW-CCSB

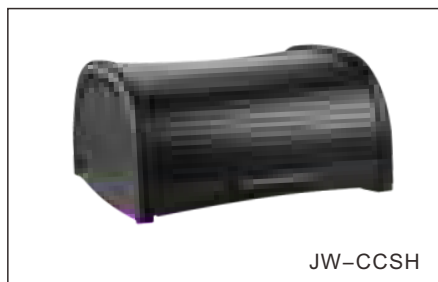

JW-CCSH



JW-VB76D

| Art.No. | Name | Size | Weight | PCS/CTN |
|-----------|---|----------------|---------|---------|
| JW-DP10 | 10 QT Disinfecting pail | 355x207x195 mm | 0.65 kg | 6 |
| JW-SB30 | 30 QT Organizing Bins | 454x362x278 mm | 1.5 kg | 6 |
| JW-MHS | Mop Holder Silicone | 72x28x18 mm | 0.02 kg | / |
| JW-MP32 | 32L Mop Buckets | 540x380x900 mm | 7.3 kg | 1 |
| JW-CR76S | 20 Gal Recycling Container(76L) | 510x275x760 mm | 3.0 kg | 6 |
| JW-CR120E | 32 Gal Recycling Container(121L) | Φ557x693 mm | 4.0 kg | 6 |
| JW-FS | Floor Sign | 298x20x620 mm | 0.6 kg | 10 |
| JW-CCDL | 30 Gal High-Capacity Vinyl Bag (Red/Blue/Green/Yellow/Black Multifunctional Cleaning Cart) | 400x330x850 mm | 0.62 kg | 24 |
| JW-CCCB | 19 Gal Recycling Bag (Yellow/Black Compact Cleaning Cart) | 380x260x720 mm | 0.52 kg | 24 |
| JW-CCSB | Storage Box | 460x280x60 mm | 0.9 kg | 6 |
| JW-CCSH | Security Compartment | 425x460x235 mm | 2.2 kg | 1 |
| JW-VB76D | Doors with Lock | 400x66x800 mm | 8.6 kg | 2 |

Housekeeping Cart

Housekeeping Cart

- The surface is easy to clean up.
- The cart is quiet designed and equipped with silent non-marking wheels of two with brakes.
- Standard equipment includes plastic bags, anti-collision devices, a vacuum storage rack and a bottom shelf.
- Large capacity cabinet can provide spacious storage space with an adjustable middle shelf.
- Ergonomically designed handle is easy to grab and control.
- An easy-control dust cover is in the upper part.
- Used to deliver food, goods and garbage in the hotel



Multi-purpose cleaning latch

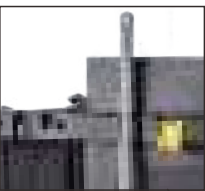

The top divider of housekeeping cart.



Black Hood for Housekeeping cart

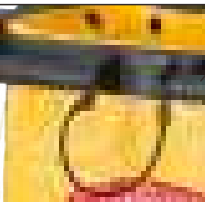
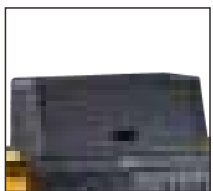

Multifunctional pull rope

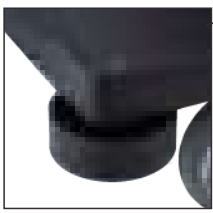

Bumper Kit



Goods Storage Rack
It can store a basket and other small items, saving storage space.

A variety of fabric bag options

Housekeeping Cart

Accessories



| Art.No. | Name | Size | Colour | Material | Weight Capacity | PCS/CTN |
|---------|---|------------------|--------|----------|-----------------|---------|
| JW-HCC1 | Standard Housekeeping Cart | 1536x610x1252 mm | Black | PP | 120 kg | 1 |
| JW-HCD2 | Standard Housekeeping cart with Lockable Door | 1536x610x1252 mm | Black | PP | 120 kg | 1 |
| JW-HCF3 | Luxury Housekeeping Cart | 1536x610x1450 mm | Black | PP | 120 kg | 1 |

Accessories

| | | | | | | |
|-----------|--|----------------|--------|-------|---|----|
| JW-HCCR | The top divider of housekeeping cart | 620x480x65 mm | Black | PC | / | 1 |
| JW-HBH | Black Hood for Housekeeping cart | 795x510x318 mm | Black | PP | / | 1 |
| JW-HBK | Bumper Kit | 140x140x50 mm | Black | PE | / | 4 |
| JW-HVB76D | Lockable Door | 440x760 mm | Black | PP | / | 2 |
| JW-9P | 9-Pocket Organizer Caddy Bag for Housekeeping Cart | 700x430 mm | Black | Vinyl | / | 1 |
| JW-CSLM | Side-Load Mesh Bag | 380x260x720 mm | Black | Vinyl | / | 24 |
| JW-CCWH | Vinyl-Lined Bag – High Capacity | 380x260x720 mm | Black | Vinyl | / | 24 |
| JW-CCSD | Recycling Bag | 380x260x720 mm | Yellow | Vinyl | / | 24 |

Step-on Container

Step-on Container

- Provides easy access to the container without the need to lift.
- The sealed lid can prevent odor from spilling.
- Tough, puncture-resistant, all-plastic construction won't rust or damage.
- Heavy pedal for hands-free use, avoiding cross infection.
- Material; HDPE&PP.
- Colour: Beige.



The inner barrel can be taken out to be cleaned and used alone.



The lid can be opened by stepping on the pedal according to the Lever Principle.



| Art.NO. | Name | Size | Capacity | PCS/CTN |
|-----------|--|----------------|--------------|---------|
| JW-CPT30 | 30.3L Step-on Container | 400x380x440 mm | 30.3L/8Gal. | 4 |
| JW-CPT45 | 45.5L Step-on Container | 400x380x600 mm | 45.4L/12Gal. | 3 |
| JW-CPT68 | 68.1L Step-on Container | 500x400x670 mm | 68.1L/18Gal. | 3 |
| JW-CPT87 | 87.1L Step-on Container | 500x400x840 mm | 87.1L/23Gal. | 2 |
| JW-CPT30W | 30.3L Step-on Container without Inner Barrel | 480x380x440 mm | 30.3L/8Gal. | 4 |
| JW-CPT45W | 45.5L Step-on Container without Inner Barrel | 400x380x600 mm | 45.5L/12Gal. | 3 |
| JW-CPT68W | 68.1L Step-on Container without Inner Barrel | 500x400x670 mm | 68.1L/18Gal. | 3 |
| JW-CPT87W | 87.1L Step-on Container without Inner Barrel | 500x400x840 mm | 87.1L/23Gal. | 2 |

Optional



JW-CIB30



JW-CIB45



JW-CIB68



JW-CIB87

| Art.NO. | Name | Size | Capacity | PCS/CTN |
|----------|--------------------|----------------|--------------------------|---------|
| JW-CIB30 | 30.3L Inner Barrel | 354x288x350 mm | Inner Barrel Is Optional | 6 |
| JW-CIB45 | 45.5L Inner Barrel | 354x288x516 mm | Inner Barrel Is Optional | 6 |
| JW-CIB68 | 68.1L Inner Barrel | 453x300x574 mm | Inner Barrel Is Optional | 6 |
| JW-CIB87 | 87.1L Inner Barrel | 453x300x736 mm | Inner Barrel Is Optional | 6 |

Recycling Slim Container

Recycling Slim Container

- With interchangeable and different color coded lids for better garbage classification.
- Blue lid with rectangular hole for paper waster.
- Green lid with two round holes for glass bottles, jars and metal cans.
- Grey handle lid for common waster.



Slim Container Dolly

- For easy transportation.
- One compartment and two compartment dolly can make up three or four compartment dolly. It's convenient for classify garbage with different lids.
- Three or four compartment dolly are made up through connecting with buckles.



Recycling Slim Container

| Art.No. | Name | Size | Colour | Material | Weight | PCS/CTN |
|----------|--------------------------|----------------|-----------------|----------|--------|---------|
| JW-CR76S | Recycling Slim Container | 509x281x760 mm | Gray/Blue/Black | PE | 3.5 kg | 6 |

Lid For Recycling Slim Container

| Art.No. | Name | Size | Colour | Material | Weight | PCS/CTN |
|---------|------------------|---------------|--------|----------|--------|---------|
| JW-CRPL | Paper Lid | 516x290x93 mm | Blue | PP | 0.4 kg | 6 |
| JW-CRHL | Handle Lid | 516x290x93 mm | Grey | PP | 0.4 kg | 6 |
| JW-CRBL | Bottle & Can Lid | 516x290x93 mm | Green | PP | 0.4 kg | 6 |

Dolly For Recycling Slim Container

| Art.No. | Name | Size | Colour | Material | Weight | PCS/CTN |
|-----------|--------------------------|----------------|--------|----------|--------|---------|
| JW-SD2312 | Single Compartment Dolly | 580x309x195 mm | Black | PP | 2.1 kg | 1 |
| JW-DD2324 | Double Compartment Dolly | 580x610x195 mm | Black | PP | 3.6 kg | 1 |

Vented Channel Container

Vented Channel Container

- With a unique design, cross-ventilation is created inside and this makes easier dumping.
- The buckles fasten the garbage bags
- Handles on both sides make easier job.
- It can be conveniently transported with a dolly.



Ventilated design saves 60% pull out strength



The buckles fasten the garbage bags. Handles on both sides make easier job.



The bottom design helps effective emptying.



JW-CRSL

Swing Lid
With two self-righting highest, it can be make cleaner garbage disposal.



JW-CRHC

Hinged Cover
With a drain tank, ideal for outdoor use.

| Art.No. | Name | Size | Colour | Material | Weight | PCS/CTN |
|----------|--------------------------|----------------|--------|----------|--------|---------|
| JW-CR76V | Vented Channel Container | 566x279x760 mm | Grey | PE | 3.3 kg | 6 |
| JW-CRHC | Hinged Cover | 518x357x64 mm | Black | PP | 0.8 kg | 6 |
| JW-CRSL | Swing Lid | 557x297x140 mm | Black | PP | 2.5 kg | 6 |

Recycle Round Container

Recycle Round Container

- Never rust, concave and peel off.
- The sealed lid makes no leakage.
- Strengthened edge makes it more durable .
- Well-designed handles make easier and more comfortable work .
- Double surrounding edges at the bottom improve the stability and enhance the dragging force .
- Easy, fast and flexible transporting.
- Five swivel casters make easy control.
- Convenient assembly and disassembly.



Five swivel casters make easy control.



Snap-lock sealed lid prevents odors from spilling out, and it keeps surroundings clean.



Solid-built handles design makes easy lifting.



Pedal control makes easy disassembly.



| Art.NO. | Name | Size | Capacity | PCS/CTN |
|-----------|-----------------------------------|-------------|---------------|---------|
| JW-CR38E | 37.9L Recycle Round Container | Φ398x434 mm | 37.9L/10Gal. | 12 |
| JW-CR76E | 75.7L Recycle Round Container | Φ492x584 mm | 75.7L/20Gal. | 12 |
| JW-CR120E | 121.1L Recycle Round Container | Φ557x693 mm | 121.1L/32Gal. | 6 |
| JW-CR170E | 166.5L Recycle Round Container | Φ617x794 mm | 166.5L/44Gal. | 6 |
| JW-CR210E | 208.2L Recycle Round Container | Φ679x840 mm | 208.2L/55Gal. | 6 |
| JW-RCD | Dolly For Recycle Round Container | Φ460x164 mm | / | 2 |

Note: JW-RCD Dolly can be used for JW-CR76E、JW-CR120E、JW-CR170E、JW-CR210E.

Lid For Recycle Round Container

| Art.NO. | Name | Size | Suitable | PCS/CTN |
|----------|---------------------------------|------------|-----------|---------|
| JW-CRC1P | Lid For Recycle Round Container | Φ410x28 mm | JW-CR38E | 24 |
| JW-CRC2P | Lid For Recycle Round Container | Φ500x40 mm | JW-CR76E | 12 |
| JW-CRC3P | Lid For Recycle Round Container | Φ570x38 mm | JW-CR120E | 12 |
| JW-CRC4P | Lid For Recycle Round Container | Φ633x38 mm | JW-CR170E | 12 |
| JW-CRC5P | Lid For Recycle Round Container | Φ690x49 mm | JW-CR210E | 12 |



Cleaning Tool



| | | |
|---------|--------------------------------|---------------------------------|
| Art.No. | JW-FRW8 | JW-FRW13 |
| Name | 8L Fire Resistant Wastebaskets | 13L Fire Resistant Wastebaskets |
| Size | 240x168x265 mm | 275x210x315 mm |
| PCS/CTN | 20 | 20 |



| | | | |
|---------|-----------------------------|----------------------|-----------------------------|
| Art.No. | JW-CTB1015 | JW-CTH-4 | JW-WGS/JW-SHB |
| Name | Multifunctional Carry Caddy | Cleaning Tool Holder | Upright Dust Pan With Cover |
| Size | 386x275x170 mm | 462x55x60 mm | / |
| PCS/CTN | 6 | 24 | 12 |

Cleaning Tool



NEW!

| | |
|---------|-----------------|
| Art.No. | JW-PF1.5 |
| Name | Cup Holder Clip |
| Size | 63x36x16 mm |
| PCS/CTN | 480 |



NEW!

| | | | |
|---------|----------------------|----------------------|----------------------|
| Art.No. | JW-GWB3 | JW-GWB2 | JW-GWB1 |
| Name | Triple Glass Washers | Triple Glass Washers | Triple Glass Washers |
| Size | 185x85x190 mm | 185x85x255 mm | 185x85x255 mm |
| PCS/CTN | 12 | 12 | 12 |



NEW!

| | |
|---------|-------------------------|
| Art.No. | JW-KOS |
| Name | Knee operated Hand sink |
| Size | 400x330x570 mm |
| PCS/CTN | 1 |



NEW!

| | |
|---------|----------------------|
| Art.No. | JW-CLT |
| Name | Cone Laundry trolley |
| Size | 900x650x850 mm |
| PCS/CTN | 1 |



Upright Electric Glass Washer

Upright Electric Glass Washer

- Applicable to all kinds of stem cup, beer cups, coffee cups, water cups, etc.
- Material of 304, anti-rust, anti-corrosion, durable.
- Brush snap design, easy to install and replace.
- 360 ° cleaning without any dead angle.
- The operation is simple and fast which can wash .
- 700-800 cups per hour.
- The high water level warning line of 26cm.
- Anti-skid rubber foot plug.
- Cleaning equipment specially designed for hotels, restaurants, bars, chain stores, etc.



JW-GW01



Anti-splash switch



Ergonomic handle



Snap on design, quick assembly and disassembly



The best water depth



10A plug with protection function

| Art.NO. | Name | Voltage | Power | Capacity | Size | PCS/CTN |
|----------|-------------------------------|-----------|-------|--------------------------|---------------|---------|
| JW-GW500 | Upright Electric Glass Washer | 110V-230V | 250W | 700-800 glasses per hour | 375x210x415mm | 1 |
| JW-GW01 | Cup Washer Brush | | | | 68x68x190mm | 10 |

Five Brush Electric Glass Polisher

Five Brush Electric Glass Polisher

- Applicable to all kinds of stem cup, beer cups, coffee cups, water cups, etc.
- 304 stainless body, anti-rust, anti-corrosion, durable, and easy to clean.
- Microfiber brush, antibacterial and durable, no hair falling.
- Brush replaceable and washable.
- 360 ° cleaning without any dead angle and polishing are carried out synchronously.
- Instant drying, high temperature ozone sterilization.
- Hot air temperature 50-60 °C.
- Simple and efficient, which can wash 350-400 cups per hour.
- Anti-skid rubber foot plug.
- Cleaning equipment specially designed for hotels, restaurants, bars, chain stores, etc.



JW-GP01

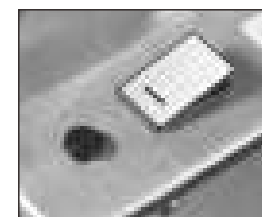

Overload protection and anti-splash switch

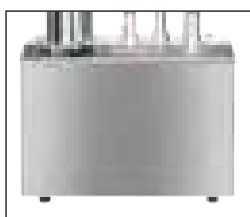

304 anti-rust body, easy to clean

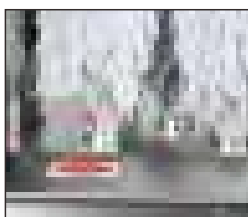

Snap on design, quick assembly and disassembly

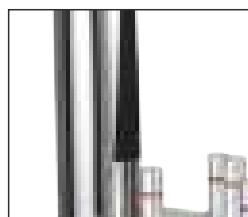

High temperature ozone tuyere



10A plug with protection function

| Art.NO. | Name | Voltage | Power | Capacity | Size | PCS/CTN |
|---------|------------------------------------|-----------|-------|--------------------------|---------------|---------|
| JW-GP05 | Five Brush Electric Glass Polisher | 110V-230V | 1000W | 350-400 glasses per hour | 335x270x490mm | 1 |
| JW-GP01 | Cup Brush | / | / | / | 100x100x225mm | 10 |

Product Index

| Art.No | Page | Art.No | Page | Art.No | Page | Art.No | Page |
|----------|------|----------|------|----------|------|----------|------|
| CN241863 | 81 | EN242163 | 79 | JW-1009A | 35 | JW-1513C | 40 |
| CN241871 | 81 | EN242171 | 79 | JW-1009C | 35 | JW-1514A | 40 |
| CN242163 | 81 | EN242463 | 79 | JW-1010A | 5 | JW-1514C | 40 |
| CN242171 | 81 | EN242471 | 79 | JW-1010C | 35 | JW-1515A | 40 |
| CN242463 | 81 | EN301863 | 79 | JW-1012A | 35 | JW-1515C | 40 |
| CN242471 | 81 | EN301871 | 79 | JW-1012C | 35 | JW-1518A | 40 |
| CN301863 | 81 | EN302163 | 79 | JW-1014A | 35 | JW-1518C | 40 |
| CN301871 | 81 | EN302171 | 79 | JW-1014C | 35 | JW-16 | 05 |
| CN302163 | 81 | EN302463 | 79 | JW-1016A | 35 | JW-1611A | 40 |
| CN302171 | 81 | EN302471 | 79 | JW-1016C | 35 | JW-1611C | 40 |
| CN302463 | 81 | EN361863 | 79 | JW-1017 | 07 | JW-1613A | 40 |
| CN302471 | 81 | EN361871 | 79 | JW-102 | 07 | JW-1613C | 40 |
| CN361863 | 81 | EN362163 | 79 | JW-1020A | 35 | JW-1615A | 40 |
| CN361871 | 81 | EN362171 | 79 | JW-1020C | 35 | JW-1615C | 40 |
| CN362163 | 81 | EN362463 | 79 | JW-103 | 07 | JW-1615C | 40 |
| CN362171 | 81 | EN362471 | 79 | JW-100A | 50 | JW-1616A | 40 |
| CN362463 | 81 | EN421863 | 79 | JW-100P | 50 | JW-1616C | 40 |
| CN362471 | 81 | EN421871 | 79 | JW-10RA | 50 | JW-1618A | 40 |
| CN421863 | 81 | EN422163 | 79 | JW-10RP | 50 | JW-1618C | 40 |
| CN421871 | 81 | EN422171 | 79 | JW-1110P | 50 | JW-162 | 05 |
| CN422163 | 81 | EN422463 | 79 | JW-1113P | 50 | JW-1708A | 39 |
| CN422171 | 81 | EN422471 | 79 | JW-110A | 50 | JW-1708C | 39 |
| CN422463 | 81 | EN481863 | 79 | JW-110P | 50 | JW-1710A | 39 |
| CN422471 | 81 | EN481871 | 79 | JW-1216A | 36 | JW-1710C | 39 |
| CN481863 | 81 | EN482163 | 79 | JW-1216C | 36 | JW-1711A | 39 |
| CN481871 | 81 | EN482171 | 79 | JW-1220A | 36 | JW-1711C | 39 |
| CN482163 | 81 | EN482463 | 79 | JW-1220C | 36 | JW-1712A | 39 |
| CN482171 | 81 | EN482471 | 79 | JW-120A | 50 | JW-1712C | 39 |
| CN482463 | 81 | EN541863 | 79 | JW-12OP | 50 | JW-1713A | 39 |
| CN482471 | 81 | EN541871 | 79 | JW-12RA | 50 | JW-1713C | 39 |
| CN541863 | 81 | EN542163 | 79 | JW-12RP | 50 | JW-1714A | 39 |
| CN541871 | 81 | EN542171 | 79 | JW-1308A | 38 | JW-1714C | 39 |
| CN542163 | 81 | EN542463 | 79 | JW-1308C | 38 | JW-172 | 07 |
| CN542171 | 81 | EN542471 | 79 | JW-1310A | 38 | JW-173 | 07 |
| CN542463 | 81 | EN601863 | 79 | JW-1310C | 38 | JW-1812C | 39 |
| CN542471 | 81 | EN601871 | 79 | JW-1311A | 38 | JW-1813C | 39 |
| CN601863 | 81 | EN602163 | 79 | JW-1311C | 38 | JW-1820C | 39 |
| CN601871 | 81 | EN602171 | 79 | JW-1312A | 38 | JW-20 | 05 |
| CN602163 | 81 | EN602463 | 79 | JW-1312C | 38 | JW-2005A | 35 |
| CN602171 | 81 | EN602471 | 79 | JW-1314A | 38 | JW-2005C | 35 |
| CN602463 | 81 | EN721863 | 79 | JW-1314C | 38 | JW-2008A | 35 |
| CN602471 | 81 | EN721871 | 79 | JW-1411A | 40 | JW-2008C | 35 |
| CN721863 | 81 | EN722163 | 79 | JW-1411C | 40 | JW-2010A | 35 |
| CN721871 | 81 | EN722171 | 79 | JW-140A | 50 | JW-2010C | 35 |
| CN722163 | 81 | EN722463 | 79 | JW-14OP | 50 | JW-2012A | 35 |
| CN722171 | 81 | EN722471 | 79 | JW-14RA | 5 | JW-2012C | 35 |
| CN722463 | 81 | JW-1006A | 35 | JW-14RP | 50 | JW-2014A | 35 |
| CN722471 | 81 | JW-1006C | 35 | JW-1512A | 40 | JW-2014C | 35 |
| EN241863 | 79 | JW-1008A | 35 | JW-1512C | 40 | JW-2016A | 35 |
| EN241871 | 79 | JW-1008C | 35 | JW-1513A | 40 | JW-2016C | 35 |

Product Index

| Art.No | Page | Art.No | Page | Art.No | Page | Art.No | Page |
|----------|------|----------|------|-----------|------|-----------|------|
| JW-2022A | 35 | JW-5050C | 37 | JW-8RP | 40 | JW-BS | 55 |
| JW-2022C | 35 | JW-5080A | 37 | JW-9 | 5 | JW-BSK | 53 |
| JW-2103C | 41 | JW-5080C | 37 | JW-9010A | 29 | JW-BSNP1 | 52 |
| JW-2105C | 41 | JW-5095A | 37 | JW-9010C | 29 | JW-BSP0.5 | 51 |
| JW-2111C | 41 | JW-5095C | 37 | JW-9011A | 29 | JW-BSP1 | 51 |
| JW-2115C | 41 | JW-5120A | 37 | JW-9011C | 29 | JW-BSP2 | 51 |
| JW-2120A | 35 | JW-5120C | 37 | JW-9012A | 29 | JW-BSP2.5 | 51 |
| JW-2120C | 35 | JW-5160A | 37 | JW-9012C | 29 | JW-BSS | 53 |
| JW-2205C | 41 | JW-5160C | 37 | JW-9013A | 29 | JW-BSW | 53 |
| JW-2206C | 41 | JW-601 | 56 | JW-9013C | 29 | JW-BV | 54 |
| JW-2207C | 41 | JW-602 | 56 | JW-92 | 5 | JW-BW | 55 |
| JW-2313A | 40 | JW-603 | 56 | JW-9P | 135 | JW-C | 08 |
| JW-2313C | 40 | JW-604C | 56 | JW-9RA | 40 | JW-C1310 | 12 |
| JW-25 | 06 | JW-6050A | 37 | JW-9RP | 40 | JW-C2113 | 12 |
| JW-252 | 06 | JW-6050C | 37 | JW-A1014A | 32 | JW-CCCB | 133 |
| JW-25B | 07 | JW-605C | 56 | JW-A1014P | 32 | JW-CCDL | 133 |
| JW-25P | 07 | JW-606C | 56 | JW-A1216A | 32 | JW-CCED | 132 |
| JW-3008A | 36 | JW-607C | 56 | JW-A1216P | 32 | JW-CCHD | 130 |
| JW-3008C | 36 | JW-6080A | 37 | JW-A1218A | 32 | JW-CCID | 131 |
| JW-3010A | 36 | JW-6080C | 37 | JW-A1218P | 32 | JW-CCL | 129 |
| JW-3010C | 36 | JW-608C | 56 | JW-A1418A | 32 | JW-CCLS | 129 |
| JW-3012A | 36 | JW-609 | 56 | JW-A1418P | 32 | JW-CCMD | 129 |
| JW-3012C | 36 | JW-6095A | 37 | JW-B | 112 | JW-CCMS | 132 |
| JW-3014A | 36 | JW-6095C | 37 | JW-B1115A | 32 | JW-CCS | 128 |
| JW-3014C | 36 | JW-610 | 56 | JW-B1115P | 32 | JW-CCSB | 133 |
| JW-3015A | 36 | JW-6120A | 37 | JW-B3B | 43 | JW-CCSH | 133 |
| JW-3015C | 36 | JW-6120C | 37 | JW-B4B | 43 | JW-CCSS | 129 |
| JW-3022A | 36 | JW-6160A | 37 | JW-B5B | 43 | JW-CCTD | 131 |
| JW-3022C | 36 | JW-6160C | 37 | JW-B6B | 43 | JW-CD2516 | 108 |
| JW-36 | 06 | JW-6210A | 37 | JW-BA | 44 | JW-CIB30 | 136 |
| JW-362 | 06 | JW-6210C | 37 | JW-BB | 44 | JW-CIB45 | 136 |
| JW-4006A | 36 | JW-6310A | 37 | JW-BC | 41 | JW-CIB87 | 136 |
| JW-4006C | 36 | JW-6310C | 37 | JW-BC2 | 41 | JW-CIN68 | 136 |
| JW-4008A | 36 | JW-64B | 07 | JW-BFB | 44 | JW-CJ250 | 47 |
| JW-4008C | 36 | JW-64I | 07 | JW-BFG | 44 | JW-CPT30 | 136 |
| JW-4009A | 36 | JW-64P | 07 | JW-BFW | 44 | JW-CPT30W | 136 |
| JW-4009C | 36 | JW-7009A | 38 | JW-BG | 44 | JW-CPT45 | 136 |
| JW-4010A | 36 | JW-7009C | 38 | JW-BH | 44 | JW-CPT45W | 136 |
| JW-4010C | 36 | JW-7011A | 38 | JW-BMC | 41 | JW-CPT68 | 136 |
| JW-4011A | 36 | JW-7011C | 38 | JW-BMQ | 41 | JW-CPT68W | 136 |
| JW-4011C | 36 | JW-7016A | 38 | JW-BMT | 41 | JW-CPT87 | 136 |
| JW-4012A | 36 | JW-7016C | 38 | JW-BMT52 | 41 | JW-CPT87W | 136 |
| JW-4012C | 36 | JW-7024A | 38 | JW-BN3 | 43 | JW-CR120E | 139 |
| JW-4015A | 36 | JW-7024C | 38 | JW-BN6D | 43 | JW-CR120W | 31 |
| JW-4015C | 36 | JW-8011P | 37 | JW-BN6L | 43 | JW-CR170E | 139 |
| JW-49 | 06 | JW-8013P | 37 | JW-BNN | 41 | JW-CR210E | 139 |
| JW-492 | 06 | JW-8016P | 37 | JW-BO | 43 | JW-CR38E | 139 |
| JW-4C | 08 | JW-8B | 07 | JW-BP | 44 | JW-CR38W | 31 |
| JW-501 | 54 | JW-8BH | 07 | JW-BPP | 44 | JW-CR76E | 139 |
| JW-5050A | 37 | JW-8RA | 50 | JW-BR | 44 | JW-CR76S | 137 |

Product Index

| Art.No | Page | Art.No | Page | Art.No | Page | Art.No | Page |
|-----------------|------|-------------|------|-----------|------|-----------|------|
| JW-CR76V | 137 | JW-FC3021 | 122 | JW-MC20 | 53 | JW-P166 | 12 |
| JW-CR76W | 31 | JW-FCC | 08 | JW-MC40 | 53 | JW-P16DS | 12 |
| JW-CRBL | 137 | JW-FCR | 08 | JW-MP32 | 133 | JW-P16FC | 11 |
| JW-CRC1P | 139 | JW-FS | 133 | JW-MTP50 | 28 | JW-P16FL | 11 |
| JW-CRC1P(WHITE) | 31 | JW-FCS | 08 | JW-MTP55 | 28 | JW-P16FLN | 11 |
| JW-CRC2P | 139 | JW-FHR | 08 | JW-MTP60 | 28 | JW-P16HC | 11 |
| JW-CRC2P(WHITE) | 31 | JW-FIFO12 | 51 | JW-MTP65 | 28 | JW-P16HH | 11 |
| JW-CRC3P | 13 | JW-FIFO16 | 51 | JW-MTP80 | 28 | JW-P16SL | 11 |
| JW-CRC3P(WHITE) | 31 | JW-FIFO20 | 51 | JW-P | 08 | JW-P192 | 12 |
| JW-CRC4P | 139 | JW-FIFO24 | 51 | JW-P112 | 12 | JW-P194 | 12 |
| JW-CRC5P | 139 | JW-FIFO32 | 51 | JW-P114 | 12 | JW-P19HC | 11 |
| JW-CRCS120 | 31 | JW-FOC | 104 | JW-P116 | 12 | JW-P19HH | 11 |
| JW-CRCS38 | 31 | JW-FP | 55 | JW-P118 | 12 | JW-P19SL | 11 |
| JW-CRCS76 | 31 | JW-FPP | 55 | JW-P11DS | 12 | JW-P216 | 12 |
| JW-CRHC | 138 | JW-FRC | 08 | JW-P11FC | 11 | JW-P218 | 12 |
| JW-CRHL | 137 | JW-FRS | 08 | JW-P11HC | 11 | JW-P21FC | 11 |
| JW-CRPL | 137 | JW-FRW13 | 140 | JW-P11HH | 11 | JW-P24HC | 11 |
| JW-CRSL | 137 | JW-FRW8 | 140 | JW-P11SL | 11 | JW-PF0592 | 95 |
| JW-CTB1015 | 140 | JW-GBM | 53 | JW-P122 | 12 | JW-PF1.5 | 141 |
| JW-CTH-4 | 140 | JW-GRC | 08 | JW-P124 | 12 | JW-PK05 | 95 |
| JW-DA | 131 | JW-GS03 | 96 | JW-P126 | 12 | JW-PK10 | 95 |
| JW-D1 | 131 | JW-GS05 | 96 | JW-P128 | 12 | JW-PR26 | 107 |
| JW-D1217A | 42 | JW-GS06 | 96 | JW-P12DS | 12 | JW-PRC | 107 |
| JW-D1217P | 42 | JW-GSM | 53 | JW-P12FC | 11 | JW-PS113 | 93 |
| JW-DB18263 | 30 | JW-GWB1 | 141 | JW-P12FL | 11 | JW-PS123 | 93 |
| JW-DB18266 | 30 | JW-GWB2 | 141 | JW-P12FLN | 11 | JW-PS13 | 89 |
| JW-DB20 | 28 | JW-GWB3 | 141 | JW-P12HC | 11 | JW-PS131 | 93 |
| JW-DB2282 | 98 | JW-HC46 | 51 | JW-P12HH | 11 | JW-PS132 | 93 |
| JW-DB2282-01 | 98 | JW-HCC1 | 134 | JW-P12SL | 11 | JW-PS13B | 93 |
| JW-DB2282-02 | 98 | JW-HCCR | 134 | JW-P132 | 12 | JW-PS141 | 93 |
| JW-DBC1826 | 30 | JWHCD2 | 134 | JW-P134 | 12 | JW-PS142 | 93 |
| JW-DC12B | 112 | JW-HCF3 | 134 | JW-P136 | 12 | JW-PS18 | 89 |
| JW-DC160 | 114 | JW-HD3624 | 123 | JW-P138 | 12 | JW-PS201 | 95 |
| JW-DC240 | 114 | JW-I001 | 56 | JW-P13DS | 12 | JW-PS206 | 95 |
| JW-DC320 | 114 | JW-I002 | 56 | JW-P13FC | 11 | JW-PS211 | 94 |
| JW-DC40 | 112 | JW-I003 | 56 | JW-P13FL | 11 | JW-PS221 | 94 |
| JW-DC46 | 51 | JW-I004 | 56 | JW-P13FLN | 11 | JW-PS225 | 94 |
| JW-DC48 | 112 | JW-I005 | 56 | JW-P13HC | 11 | JW-PS245 | 94 |
| JW-DC48B | 112 | JW-INC18L | 103 | JW-P13HH | 11 | JW-PS248 | 94 |
| JW-DC80 | 112 | JW-INC44.5L | 103 | JW-P13SL | 11 | JW-PS250 | 95 |
| JW-DC84 | 112 | JW-INC7L | 103 | JW-P142 | 12 | JW-PS255 | 95 |
| JW-DD2324 | 142 | JW-INC9.4L | 103 | JW-P144 | 12 | JW-PS260 | 94 |
| JW-DOW | 104 | JW-INF100H | 107 | JW-P146 | 12 | JW-PS301 | 95 |
| JW-DP10 | 134 | JW-INF150H | 107 | JW-P14DS | 12 | JW-PS306 | 95 |
| JW-E1218A | 42 | JW-INF200H | 107 | JW-P14FC | 11 | JW-PS321 | 94 |
| JW-E1218P | 42 | JW-LBSD12 | 51 | JW-P14HC | 11 | JW-PS325 | 94 |
| JW-EPP160 | 108 | JW-LBSD24 | 51 | JW-P14HH | 11 | JW-PS33 | 89 |
| JW-EPP180 | 108 | JW-LBSD32 | 51 | JW-P14SL | 11 | JW-PS38 | 89 |
| JW-EPP400 | 108 | JW-LBSD8 | 51 | JW-P162 | 12 | JW-PSC14 | 119 |
| JW-FC2115 | 122 | JW-LC46 | 51 | JW-P164 | 12 | JW-PSC19 | 119 |

Product Index

| Art.No | Page | Art.No | Page | Art.No | Page | Art.No | Page |
|------------|------|------------|------|--------------|------|--------|------|
| JW-PSC22 | 119 | JW-SH9 | 119 | JW-W800C | 48 | P-041 | 44 |
| JW-PSC26 | 119 | JW-SHB | 140 | JW-W900A | 48 | P-042 | 44 |
| JW-R1014CT | 43 | JW-SIF | 104 | JW-W900C | 48 | P-042A | 44 |
| JW-R1014P | 43 | JW-SIN | 104 | JW-WGS | 140 | P-043 | 44 |
| JW-R1100CT | 43 | JW-SK280C | 47 | JW-WM12 | 116 | P-043A | 44 |
| JW-R1100P | 43 | JW-SK280D | 47 | JW-WM18 | 116 | P-046 | 31 |
| JW-R1216CT | 43 | JW-SK280F | 47 | JW-WM21 | 116 | P-050 | 46 |
| JW-R1216P | 43 | JW-SK280LC | 47 | JW-WM6 | 116 | P-060C | 23 |
| JW-R1400CT | 43 | JW-SK280LD | 47 | JW-WM9 | 116 | P-060P | 23 |
| JW-R1400P | 43 | JW-SK280LF | 47 | JW-WSC3614 | 82 | P-061C | 23 |
| JW-R1418CT | 43 | JW-SK280LM | 47 | JW-WSC4814 | 82 | P-061P | 23 |
| JW-R1418P | 43 | JW-SK280LN | 47 | JW-WSS3614 | 82 | P-062C | 23 |
| JW-R1520CT | 43 | JW-SK280LP | 47 | JW-WSS4814 | 82 | P-062P | 23 |
| JW-R1520P | 43 | JW-SK280M | 47 | JW-WV3952 | 98 | P-063C | 23 |
| JW-R1600CT | 43 | JW-SK280N | 47 | JW-WV3952-01 | 98 | P-063P | 23 |
| JW-R1600P | 43 | JW-SK280P | 47 | JW-X3001 | 56 | P-064C | 23 |
| JW-R1622CT | 43 | JW-SLI | 107 | JW-X4501 | 56 | P-064P | 23 |
| JW-R1622P | 43 | JW-SP19 | 32 | JW-X6001 | 56 | P-065C | 23 |
| JW-R1800CT | 43 | JW-SP9.5 | 32 | JW-X8001 | 56 | P-065P | 23 |
| JW-R1826CT | 43 | JW-SSB100 | 49 | JW-X9001 | 56 | P-066C | 23 |
| JW-R2500CT | 43 | JW-SSB115 | 49 | JW-XC150 | 120 | P-066P | 23 |
| JW-R2700CT | 43 | JW-SSB60 | 49 | JW-XC300 | 120 | P-067C | 23 |
| JW-R2900CT | 43 | JW-SSB80 | 49 | JW-XC300M | 120 | P-067P | 23 |
| JW-R3020CT | 43 | JW-SSD1826 | 30 | P-001 | 44 | P-068C | 23 |
| JW-R3100CT | 43 | JW-ST | 08 | P-002 | 44 | P-068P | 23 |
| JW-RB150 | 120 | JW-TC30 | 119 | P-003 | 44 | P-069C | 26 |
| JW-RB261B | 88 | JW-TC46 | 51 | P-004 | 45 | P-069P | 27 |
| JW-RB300 | 120 | JW-TRT | 118 | P-005 | 45 | P06DS | 26 |
| JW-RIS1 | 103 | JW-VB76D | 133 | P-006 | 46 | P06DSP | 27 |
| JW-RIS2 | 103 | JW-VC40 | 32 | P-007 | 46 | P-070C | 26 |
| JW-RT | 08 | JW-VC46 | 32 | P-008 | 46 | P-070P | 27 |
| JW-S | 06 | JW-VC48 | 49 | P-009 | 46 | P-071C | 26 |
| JW-S1000C | 49 | JW-VC80 | 49 | P-010 | 46 | P-071P | 27 |
| JW-S102 | 29 | JW-VC84 | 49 | P-011 | 46 | P-072C | 26 |
| JW-S120 | 29 | JW-VO23 | 33 | P-012 | 44 | P-072P | 27 |
| JW-S1200C | 49 | JW-VO24 | 33 | P-012C | 44 | P-073C | 26 |
| JW-S1500C | 49 | JW-VO33 | 33 | P-013 | 44 | P-073P | 27 |
| JW-S1800C | 49 | JW-VO34 | 33 | P-014 | 44 | P-074C | 26 |
| JW-S20 | 29 | JW-VOB | 33 | P-015 | 44 | P-074P | 27 |
| JW-S40 | 29 | JW-W1000A | 48 | P-016 | 44 | P07DS | 26 |
| JW-S8 | 29 | JW-W1000C | 48 | P-017 | 44 | P07DSP | 27 |
| JW-S81 | 29 | JW-W1290C | 48 | P-018 | 44 | P-080 | 23 |
| JW-SB30 | 133 | JW-W1511C | 48 | P-030 | 54 | P-081 | 23 |
| JW-SB34 | 133 | JW-W500A | 48 | P-031 | 54 | P-082 | 23 |
| JW-SC106 | 54 | JW-W500C | 48 | P-032 | 54 | P-083C | 26 |
| JW-SC110 | 54 | JW-W600A | 48 | P-033 | 54 | P-083P | 26 |
| JW-SC76 | 54 | JW-W600C | 48 | P-034 | 54 | P-084C | 26 |
| JW-SD2313 | 137 | JW-W700A | 48 | P-038 | 53 | P-084P | 26 |
| JW-SED | 119 | JW-W700C | 48 | P-039 | 53 | P-085 | 28 |
| JW-SEDO | 119 | JW-W800A | 48 | P-040 | 44 | P-086 | 28 |

Product Index

| Art.No | Page | Art.No | Page | Art.No | Page | Art.No | Page |
|---------|------|------------|------|------------|------|------------|------|
| P-090C | 24 | PSS361864 | 66 | PSU361480 | 64 | PSU542464 | 64 |
| P-090P | 25 | PSS361872 | 66 | PSU361864 | 64 | PSU542472 | 64 |
| P-091C | 24 | PSS362164 | 66 | PSU361872 | 64 | PSU542472M | 70 |
| P-091P | 25 | PSS362172 | 66 | PSU361880 | 64 | PSU542480 | 64 |
| P-092C | 24 | PSS362172M | 70 | PSU362164 | 64 | PSU601464 | 64 |
| P-092P | 25 | PSS362464 | 66 | PSU362172 | 64 | PSU601472 | 64 |
| P-093C | 24 | PSS362472 | 66 | PSU362172M | 70 | PSU601480 | 64 |
| P-093P | 25 | PSS362472M | 70 | PSU362180 | 64 | PSU601864 | 64 |
| P-100C | 24 | PSS421864 | 66 | PSU362464 | 64 | PSU601872 | 64 |
| P-100P | 25 | PSS421872 | 66 | PSU362472 | 64 | PSU601880 | 64 |
| P-101C | 24 | PSS422164 | 66 | PSU362472M | 70 | PSU602164 | 64 |
| P-101P | 25 | PSS422172 | 66 | PSU362480 | 64 | PSU602172 | 64 |
| P-102P | 25 | PSS422172M | 70 | PSU421464 | 64 | PSU602172M | 70 |
| P-103C | 24 | PSS422464 | 66 | PSU421472 | 64 | PSU602180 | 64 |
| P-103P | 25 | PSS422472 | 66 | PSU421480 | 64 | PSU602464 | 64 |
| P-104C | 24 | PSS422472M | 70 | PSU421864 | 64 | PSU602472 | 64 |
| P-104P | 25 | PSS481864 | 66 | PSU421872 | 64 | PSU602472M | 70 |
| P-105C | 24 | PSS481872 | 66 | PSU421880 | 64 | PSU602480 | 64 |
| P-105P | 25 | PSS482164 | 66 | PSU422164 | 64 | PSU721464 | 64 |
| P-106C | 24 | PSS482172 | 66 | PSU422172 | 64 | PSU721472 | 64 |
| P-106P | 25 | PSS482172M | 70 | PSU422172M | 70 | PSU721480 | 64 |
| P-107C | 24 | PSS482464 | 66 | PSU422180 | 64 | PSU721864 | 64 |
| P-107P | 25 | PSS482472 | 66 | PSU422464 | 64 | PSU721872 | 64 |
| P-035 | 44 | PSS482472M | 70 | PSU422472 | 64 | PSU721880 | 64 |
| P-036 | 44 | PSS541864 | 66 | PSU422472M | 70 | PSU722164 | 64 |
| P-037 | 44 | PSS541872 | 66 | PSU422480 | 64 | PSU722172 | 64 |
| PSH3614 | 63 | PSS542164 | 66 | PSU481464 | 64 | PSU722172M | 70 |
| PSH3618 | 63 | PSS542172 | 66 | PSU481472 | 64 | PSU722180 | 64 |
| PSH3621 | 63 | PSS542172M | 70 | PSU481480 | 64 | PSU722464 | 64 |
| PSH3624 | 63 | PSS542464 | 66 | PSU481864 | 64 | PSU722472 | 64 |
| PSH4214 | 63 | PSS542472 | 66 | PSU481872 | 64 | PSU722472M | 70 |
| PSH4218 | 63 | PSS542472M | 70 | PSU481880 | 64 | PSU722480 | 64 |
| PSH4221 | 63 | PSS601864 | 66 | PSU482164 | 64 | SN241863 | 81 |
| PSH4224 | 63 | PSS601872 | 66 | PSU482172 | 64 | SN241871 | 81 |
| PSH4814 | 63 | PSS602164 | 66 | PSU482172M | 70 | SN242163 | 81 |
| PSH4818 | 63 | PSS602172 | 66 | PSU482180 | 64 | SN242171 | 81 |
| PSH4821 | 63 | PSS602172M | 70 | PSU482464 | 64 | SN242463 | 81 |
| PSH4824 | 63 | PSS602464 | 66 | PSU482472 | 64 | SN242471 | 81 |
| PSH5414 | 63 | PSS602472 | 66 | PSU482472M | 70 | SN301863 | 81 |
| PSH5418 | 63 | PSS602472M | 70 | PSU482480 | 64 | SN301871 | 81 |
| PSH5421 | 63 | PSS721864 | 66 | PSU541464 | 64 | SN302163 | 81 |
| PSH5424 | 63 | PSS721872 | 66 | PSU541472 | 64 | SN302171 | 81 |
| PSH6014 | 63 | PSS722164 | 66 | PSU541480 | 64 | SN302463 | 81 |
| PSH6018 | 63 | PSS722172 | 66 | PSU541864 | 64 | SN302471 | 81 |
| PSH6021 | 63 | PSS722172M | 70 | PSU541872 | 64 | SN361863 | 86 |
| PSH6024 | 63 | PSS722464 | 66 | PSU541880 | 64 | SN361871 | 81 |
| PSH7214 | 63 | PSS722472 | 66 | PSU542164 | 64 | SN362163 | 81 |
| PSH7218 | 63 | PSS722472M | 70 | PSU542172 | 64 | SN362171 | 81 |
| PSH7221 | 63 | PSU361464 | 64 | PSU542172M | 70 | SN362463 | 81 |
| PSH7224 | 63 | PSU361472 | 64 | PSU542180 | 64 | SN362471 | 81 |

Product Index

| Art.No | Page | Art.No | Page | Art.No | Page | Art.No | Page |
|--------------------------|------|-----------|------|-----------|------|-----------|------|
| Sn421863 | 81 | CSU302464 | 75 | CSU602180 | 75 | CSA541872 | 76 |
| SN421871 | 81 | CSU301872 | 75 | CSU602480 | 75 | CSA542172 | 76 |
| SN422163 | 81 | CSU302172 | 75 | CSU721864 | 75 | CSA542472 | 76 |
| Sn422171 | 81 | CSU302472 | 75 | CSU722164 | 75 | CSA541880 | 76 |
| Sn422463 | 81 | CSU301880 | 75 | CSU722464 | 75 | CSA542180 | 76 |
| SN422471 | 81 | CSU302180 | 75 | CSU721872 | 75 | CSA542480 | 76 |
| SN481863 | 81 | CSU302480 | 75 | CSU722172 | 75 | CSA601864 | 76 |
| SN481871 | 81 | CSU361864 | 75 | CSU722472 | 75 | CSA602164 | 76 |
| SN482163 | 81 | CSU362164 | 75 | CSU721880 | 75 | CSA602464 | 76 |
| SN482171 | 81 | CSU362464 | 75 | CSU722180 | 75 | CSA601872 | 76 |
| SN482463 | 81 | CSU361872 | 75 | CSU722480 | 75 | CSA602172 | 76 |
| SN482471 | 81 | CSU362172 | 75 | CSA301864 | 76 | CSA602472 | 76 |
| SN541863 | 81 | CSU362472 | 75 | CSA302164 | 76 | CSA601880 | 76 |
| SN541871 | 81 | CSU361880 | 75 | CSA302464 | 76 | CSA602180 | 76 |
| SN542163 | 81 | CSU302180 | 75 | CSA301872 | 76 | CSA602480 | 76 |
| SN542171 | 81 | CSU302480 | 75 | CSA302172 | 76 | CSA721864 | 76 |
| SN542463 | 81 | CSU421864 | 75 | CSA302472 | 76 | CSA722164 | 76 |
| SN542471 | 81 | CSU422164 | 75 | CSA301880 | 76 | CSA722464 | 76 |
| SN601863 | 81 | CSU422464 | 75 | CSA302180 | 76 | CSA721872 | 76 |
| SN601871 | 81 | CSU421872 | 75 | CSA302480 | 76 | CSA722172 | 76 |
| SN602163 | 81 | CSU422172 | 75 | CSA361864 | 76 | CSA722472 | 76 |
| SN602171 | 81 | CSU422472 | 75 | CSA362164 | 76 | CSA721880 | 76 |
| SN602463 | 81 | CSU421880 | 75 | CSA362464 | 76 | CSA722180 | 76 |
| SN602471 | 81 | CSU422180 | 75 | CSA361872 | 76 | CSA722480 | 76 |
| SN721863 | 81 | CSU422480 | 75 | CSA362172 | 76 | CSS301864 | 77 |
| SN721871 | 81 | CSU481864 | 75 | CSA362472 | 76 | CSS302164 | 77 |
| SN722163 | 81 | CSU482164 | 75 | CSA361880 | 76 | CSS302464 | 77 |
| SN722171 | 81 | CSU482464 | 75 | CSA302180 | 76 | CSS301872 | 77 |
| SN722463 | 81 | CSU481872 | 75 | CSA302480 | 76 | CSS302172 | 77 |
| SN722471 | 81 | CSU482172 | 75 | CSA421864 | 76 | CSS302472 | 77 |
| JW-SL06 | 46 | CSU482472 | 75 | CSA422164 | 76 | CSS301880 | 77 |
| JW-SL09 | 46 | CSU481880 | 75 | CSA422464 | 76 | CSS302180 | 77 |
| JW-610A | 56 | CSU482180 | 75 | CSA421872 | 76 | CSS302480 | 77 |
| JW-610B | 56 | CSU482480 | 75 | CSA422172 | 76 | CSS361864 | 77 |
| JW-GS07 | 91 | CSU541864 | 75 | CSA422472 | 76 | CSS362164 | 77 |
| JW-EPP170E NEW! | 110 | CSU542164 | 75 | CSA421880 | 76 | CSS362464 | 77 |
| JW-ADCS240 NEW! | 113 | CSU542464 | 75 | CSA422180 | 76 | CSS361872 | 77 |
| JW-GF-8P NEW! | 92 | CSU541872 | 75 | CSA422480 | 76 | CSS362172 | 77 |
| JW-GF-14P NEW! | 92 | CSU542172 | 75 | CSA481864 | 76 | CSS362472 | 77 |
| JW-GF-8P-WS NEW! | 92 | CSU542472 | 75 | CSA482164 | 76 | CSS361880 | 77 |
| JW-GF-14P-WS NEW! | 92 | CSU541880 | 75 | CSA482464 | 76 | CSS302180 | 77 |
| JW-GR13 NEW! | 92 | CSU542180 | 75 | CSA481872 | 76 | CSS302480 | 77 |
| JW-GR13B NEW! | 92 | CSU542480 | 75 | CSA482172 | 76 | CSS421864 | 77 |
| JW-GR16 NEW! | 92 | CSU601864 | 75 | CSA482472 | 76 | CSS422164 | 77 |
| JW-GR16B NEW! | 92 | CSU602164 | 75 | CSA481880 | 76 | CSS422464 | 77 |
| JW-GR1608 NEW! | 92 | CSU602464 | 75 | CSA482180 | 76 | CSS421872 | 77 |
| JW-GR2508 NEW! | 92 | CSU601872 | 75 | CSA482480 | 76 | CSS422172 | 77 |
| CCC | 74 | CSU602172 | 75 | CSA541864 | 76 | CSS422472 | 77 |
| CSU301864 | 74 | CSU602472 | 75 | CSA542164 | 76 | CSS421880 | 77 |
| CSU302164 | 74 | CSU601880 | 75 | CSA542464 | 76 | CSS422180 | 77 |

Product Index

| Art.No | Page | Art.No | Page | Art.No | Page | Art.No | Page |
|-----------|------|-----------|------|-----------------------|------|-----------|------|
| CSS422480 | 77 | CSE362172 | 78 | JW-SN16-1 | 85 | E-SS24HCS | 14 |
| CSS481864 | 77 | CSE362472 | 78 | JW-GS03-A NEW! | 81 | E-SS1220 | 14 |
| CSS482164 | 77 | CSE361880 | 78 | JW-DSF NEW! | 99 | E-SS1240 | 14 |
| CSS482464 | 77 | CSE302180 | 78 | JW-EPC NEW! | 106 | E-SS1255 | 14 |
| CSS481872 | 77 | CSE302480 | 78 | JW-FS | 133 | E-SS122 | 14 |
| CSS482172 | 77 | CSE421864 | 78 | JW-HCCS NEW! | 134 | E-SS124 | 14 |
| CSS482472 | 77 | CSE422164 | 78 | JW-RCD | 129 | E-SS126 | 14 |
| CSS481880 | 77 | CSE422464 | 78 | JW-KOS NEW! | 141 | E-SS128 | 14 |
| CSS482180 | 77 | CSE421872 | 78 | JW-CLT NEW! | 141 | E-SS12HC | 14 |
| CSS482480 | 77 | CSE422172 | 78 | JW-CLT NEW! | 141 | E-SS12HCS | 14 |
| CSS541864 | 77 | CSE422472 | 78 | JW-1827-1 NEW! | 101 | E-SS1320 | 14 |
| CSS542164 | 77 | CSE421880 | 78 | JW-1827-2 NEW! | 101 | E-SS1340 | 14 |
| CSS542464 | 77 | CSE422180 | 78 | JW-1829 NEW! | 101 | E-SS1355 | 14 |
| CSS541872 | 77 | CSE422480 | 78 | JW-B0665 NEW! | 101 | E-SS132 | 14 |
| CSS542172 | 77 | CSE481864 | 78 | JW-GW01 NEW! | 143 | E-SS134 | 14 |
| CSS542472 | 77 | CSE482164 | 78 | JW-GW500 NEW! | 143 | E-SS136 | 14 |
| CSS541880 | 77 | CSE482464 | 78 | JW-GP01 NEW! | 144 | E-SS138 | 14 |
| CSS542180 | 77 | CSE481872 | 78 | JW-GP05 NEW! | 144 | E-SS13HC | 14 |
| CSS542480 | 77 | CSE482172 | 78 | E-SS2120 | 14 | E-SS13HCS | 14 |
| CSS601864 | 77 | CSE482472 | 78 | E-SS2140 | 14 | E-SS1420 | 14 |
| CSS602164 | 77 | CSE481880 | 78 | E-SS2155 | 14 | E-SS1440 | 14 |
| CSS602464 | 77 | CSE482180 | 78 | E-SS212 | 14 | E-SS1455 | 14 |
| CSS601872 | 77 | CSE482480 | 78 | E-SS214 | 14 | E-SS142 | 14 |
| CSS602172 | 77 | CSE541864 | 78 | E-SS216 | 14 | E-SS144 | 14 |
| CSS602472 | 77 | CSE542164 | 78 | E-SS218 | 14 | E-SS146 | 14 |
| CSS601880 | 77 | CSE542464 | 78 | E-SS21HC | 14 | E-SS148 | 14 |
| CSS602180 | 77 | CSE541872 | 78 | E-SS21HCS | 14 | E-SS14HC | 14 |
| CSS602480 | 77 | CSE542172 | 78 | E-SS1120 | 14 | E-SS14HCS | 14 |
| CSS721864 | 77 | CSE542472 | 78 | E-SS1140 | 14 | E-SS162 | 14 |
| CSS722164 | 77 | CSE541880 | 78 | E-SS1155 | 14 | E-SS164 | 14 |
| CSS722464 | 77 | CSE542180 | 78 | E-SS112 | 14 | E-SS166 | 14 |
| CSS721872 | 77 | CSE542480 | 78 | E-SS114 | 14 | E-SS168 | 14 |
| CSS722172 | 77 | CSE601864 | 78 | E-SS116 | 14 | E-SS16HC | 14 |
| CSS722472 | 77 | CSE602164 | 78 | E-SS118 | 14 | E-SS16HCS | 14 |
| CSS721880 | 77 | CSE602464 | 78 | E-SS11HC | 14 | E-SS192 | 14 |
| CSS722180 | 77 | CSE601872 | 78 | E-SS11HCS | 14 | E-SS194 | 14 |
| CSS722480 | 77 | CSE602172 | 78 | E-SS2320 | 14 | E-SS196 | 14 |
| CSE301864 | 78 | CSE602472 | 78 | E-SS2340 | 14 | E-SS19HC | 14 |
| CSE302164 | 78 | CSE601880 | 78 | E-SS2355 | 14 | E-SS19HCS | 14 |
| CSE302464 | 78 | CSE602180 | 78 | E-SS232 | 14 | E-SS1120P | 15 |
| CSE301872 | 78 | CSE602480 | 78 | E-SS234 | 14 | E-SS1140P | 15 |
| CSE302172 | 78 | CSE721864 | 78 | E-SS236 | 14 | E-SS1155P | 15 |
| CSE302472 | 78 | CSE722164 | 78 | E-SS238 | 14 | E-SS112P | 15 |
| CSE301880 | 78 | CSE722464 | 78 | E-SS23HC | 14 | E-SS114P | 15 |
| CSE302180 | 78 | CSE721872 | 78 | E-SS23HCS | 14 | E-SS116P | 15 |
| CSE302480 | 78 | CSE722172 | 78 | E-SS2440 | 14 | E-SS118P | 15 |
| CSE361864 | 78 | CSE722472 | 78 | E-SS242 | 14 | E-SS2320P | 15 |
| CSE362164 | 78 | CSE721880 | 78 | E-SS244 | 14 | E-SS2340P | 15 |
| CSE362464 | 78 | CSE722180 | 78 | E-SS246 | 14 | E-SS2355P | 15 |
| CSE361872 | 78 | CSE722480 | 78 | E-SS24HC | 14 | E-SS232P | 15 |

Product Index

| Art.No | Page | Art.No | Page | Art.No | Page | Art.No | Page |
|-----------|------|------------|------|-----------|------|------------|------|
| E-SS234P | 15 | E-SS4134 | 16 | E-SS4234P | 17 | A-SS2340P | 19 |
| E-SS236P | 15 | E-SS4136 | 16 | E-SS4236P | 17 | A-SS232P | 19 |
| E-SS238P | 15 | E-SS4138 | 16 | E-SS4238P | 17 | A-SS234P | 19 |
| E-SS1220P | 15 | E-SS41420 | 16 | A-SS1125 | 18 | A-SS236P | 19 |
| E-SS1240P | 15 | E-SS41440 | 16 | A-SS1140 | 18 | A-SS238P | 19 |
| E-SS1255P | 15 | E-SS4142 | 16 | A-SS112 | 18 | A-SS1225P | 19 |
| E-SS122P | 15 | E-SS4144 | 16 | A-SS114 | 18 | A-SS1240P | 19 |
| E-SS124P | 15 | E-SS4146 | 16 | A-SS116 | 18 | A-SS122P | 19 |
| E-SS126P | 15 | E-SS4148 | 16 | A-SS118 | 18 | A-SS124P | 19 |
| E-SS128P | 15 | E-SS4162 | 16 | A-SS11HC | 18 | A-SS126P | 19 |
| E-SS1320P | 15 | E-SS4164 | 16 | A-SS2325 | 18 | A-SS128P | 19 |
| E-SS1340P | 15 | E-SS4166 | 16 | A-SS2340 | 18 | A-SS41125 | 20 |
| E-SS1355P | 15 | E-SS4168 | 16 | A-SS232 | 18 | A-SS4112 | 20 |
| E-SS132P | 15 | E-SS4192 | 16 | A-SS234 | 18 | A-SS4114 | 20 |
| E-SS134P | 15 | E-SS4194 | 16 | A-SS236 | 18 | A-SS4116 | 20 |
| E-SS136P | 15 | E-SS4196 | 16 | A-SS238 | 18 | A-SS4118 | 20 |
| E-SS138P | 15 | E-SS4242 | 16 | A-SS23HC | 18 | A-SS41225 | 20 |
| E-SS2120P | 15 | E-SS4244 | 16 | A-SS1225 | 18 | A-SS4122 | 20 |
| E-SS2140P | 15 | E-SS4246 | 16 | A-SS1240 | 18 | A-SS4124 | 20 |
| E-SS2155P | 15 | E-SS411HC | 16 | A-SS122 | 18 | A-SS4126 | 20 |
| E-SS212P | 15 | E-SS411HCS | 16 | A-SS124 | 18 | A-SS4128 | 20 |
| E-SS214P | 15 | E-SS412HC | 16 | A-SS126 | 18 | A-SS4232 | 20 |
| E-SS216P | 15 | E-SS412HCS | 16 | A-SS128 | 18 | A-SS4234 | 20 |
| E-SS218P | 15 | E-SS423HC | 16 | A-SS12HC | 18 | A-SS4236 | 20 |
| E-SS42120 | 16 | E-SS423HCS | 16 | A-SS132 | 18 | A-SS4238 | 20 |
| E-SS42140 | 16 | E-SS413HC | 16 | A-SS134 | 18 | A-SS4132 | 20 |
| E-SS4212 | 16 | E-SS413HCS | 16 | A-SS136 | 18 | A-SS4134 | 20 |
| E-SS4214 | 16 | E-SS414HC | 16 | A-SS138 | 18 | A-SS4136 | 20 |
| E-SS4216 | 16 | E-SS414HCS | 16 | A-SS13HC | 18 | A-SS4138 | 20 |
| E-SS41120 | 16 | E-SS416HC | 16 | A-SS142 | 18 | A-SS4142 | 20 |
| E-SS41140 | 16 | E-SS416HCS | 16 | A-SS144 | 18 | A-SS4144 | 20 |
| E-SS4112 | 16 | E-SS419HC | 16 | A-SS146 | 18 | A-SS4146 | 20 |
| E-SS4114 | 16 | E-SS419HCS | 16 | A-SS148 | 18 | A-SS4162 | 20 |
| E-SS4116 | 16 | E-SS424HC | 16 | A-SS14HC | 18 | A-SS4164 | 20 |
| E-SS4118 | 16 | E-SS424HCS | 16 | A-SS162 | 18 | A-SS4166 | 20 |
| E-SS41220 | 16 | E-SS41120P | 17 | A-SS164 | 18 | A-SS4192 | 20 |
| E-SS41240 | 16 | E-SS41140P | 17 | A-SS166 | 18 | A-SS4194 | 20 |
| E-SS4122 | 16 | E-SS4112P | 17 | A-SS168 | 18 | A-SS4242 | 20 |
| E-SS4124 | 16 | E-SS4114P | 17 | A-SS16HC | 18 | A-SS4244 | 20 |
| E-SS4126 | 16 | E-SS4116P | 17 | A-SS192 | 18 | A-SS4246 | 20 |
| E-SS4128 | 16 | E-SS4118P | 17 | A-SS194 | 18 | A-SS411HC | 20 |
| E-SS42320 | 16 | E-SS41220P | 17 | A-SS196 | 18 | A-SS411HCS | 20 |
| E-SS42340 | 16 | E-SS41240P | 17 | A-SS19HC | 18 | A-SS412HC | 20 |
| E-SS4232 | 16 | E-SS4122P | 17 | A-SS1125P | 19 | A-SS412HCS | 20 |
| E-SS4234 | 16 | E-SS4124P | 17 | A-SS1140P | 19 | A-SS423HC | 20 |
| E-SS4236 | 16 | E-SS4126P | 17 | A-SS112P | 19 | A-SS423HCS | 20 |
| E-SS4238 | 16 | E-SS4128P | 17 | A-SS114P | 19 | A-SS413HC | 20 |
| E-SS41320 | 16 | E-SS42320P | 17 | A-SS116P | 19 | A-SS413HCS | 20 |
| E-SS41340 | 16 | E-SS42340P | 17 | A-SS118P | 19 | A-SS414HC | 20 |
| E-SS4132 | 16 | E-SS4232P | 17 | A-SS2325P | 19 | A-SS414HCS | 20 |

Product Index

| Art.No | Page | Art.No | Page | Art.No | Page | Art.No | Page |
|------------------------|------|--------|------|--------|------|--------|------|
| A-SS416HC | 20 | | | | | | |
| A-SS416HCS | 20 | | | | | | |
| A-SS419HC | 20 | | | | | | |
| A-SS419HCS | 20 | | | | | | |
| A-SS424HC | 20 | | | | | | |
| A-SS424HCS | 20 | | | | | | |
| A-SS41125P | 21 | | | | | | |
| A-SS4112P | 21 | | | | | | |
| A-SS4114P | 21 | | | | | | |
| A-SS4116P | 21 | | | | | | |
| A-SS4118P | 21 | | | | | | |
| A-SS41225P | 21 | | | | | | |
| A-SS4122P | 21 | | | | | | |
| A-SS4124P | 21 | | | | | | |
| A-SS4126P | 21 | | | | | | |
| A-SS4128P | 21 | | | | | | |
| JW-RKC6-2 | 83 | | | | | | |
| JW-RKC6 | 83 | | | | | | |
| JW-RKC12 | 83 | | | | | | |
| JW-RK6 | 83 | | | | | | |
| JW-RK12 | 83 | | | | | | |
| JW-RK6-2 | 83 | | | | | | |
| JW-AMSK15 | 86 | | | | | | |
| JW-EUSK16 | 86 | | | | | | |
| JW-AMSK16 | 86 | | | | | | |
| JW-EUSK30 | 86 | | | | | | |
| JW-AMSK30 | 86 | | | | | | |
| JW-EUSK32 | 86 | | | | | | |
| JW-AMSK32 | 86 | | | | | | |
| JW-RK16 | 85 | | | | | | |
| JW-RK32 | 85 | | | | | | |
| JW-RK16-2 | 85 | | | | | | |
| JW-GSSB | 91 | | | | | | |
| JW-IPC NEW! | 105 | | | | | | |
| JW-CT12 NEW! | 121 | | | | | | |
| JW-HD3416 NEW! | 124 | | | | | | |
| JW-HD4025 NEW! | 124 | | | | | | |
| JW-HD4324 NEW! | 124 | | | | | | |
| JW-HDF4425 NEW! | 124 | | | | | | |
| JW-BCS NEW! | 126 | | | | | | |
| JW-CD4 | 33 | | | | | | |
| JW-FC1060 | 42 | | | | | | |
| PSC | 73 | | | | | | |
| PSW | 73 | | | | | | |
| | | | | | | | |
| | | | | | | | |
| | | | | | | | |
| | | | | | | | |
| | | | | | | | |
| | | | | | | | |
| | | | | | | | |
| | | | | | | | |
| | | | | | | | |
| | | | | | | | |
| | | | | | | | |
| | | | | | | | |



Absorption Achieves Future



Add: No.15 Zhian North Road Jun'an Town,
Shunde District, Foshan, Guangdong, China

Tel: +86-757-25590999
Fax:+86-757-25386099

E-mail:sales@gzwins.com
Http://www.jiwins.cn